

Numerical Heat Transfer

Chapter 3 Numerical Methods for Solving Diffusion Equation and their Applications (1)

(Chapter 4 of Textbook)



Instructor Tao, Wen-Quan

**Key Laboratory of Thermo-Fluid Science & Engineering
Int. Joint Research Laboratory of Thermal Science & Engineering
Xi'an Jiaotong University
Innovative Harbor of West China, Xian**

2022-Sept-20

Contents (Chapter 4 of Textbook)

Remarks: Chapter 3 in the textbook will be studied later for the students' convenience of understanding

3.1 1-D Heat Conduction Equation

3.2 Fully Implicit Scheme of Multi-dimensional Heat Conduction Equation

3.3 Treatments of Source Term and B.C.

3.4 TDMA & ADI Methods for Solving ABEs

3.5 Fully Developed HT in Circular Tubes

3.6* Fully Developed HT in Rectangle Ducts

3.1 1-D Heat Conduction Equation

3.1.1 General equation of 1-D steady heat conduction

3.1.2 Discretization of G.G.E. by CV method

3.1.3 Determination of interface thermal conductivity

3.1.4 Discretization of 1-D unsteady heat conduction equation

3.1.5 Mathematical stability can't guarantee solution physically meaningful (有意义的)

3.1 1-D Heat Conduction Equation

3.1.1 G.E. of 1-D steady heat conduction

1. Two ways of coding for solving engineering problems

Special code(专用程序): FLOWTHERN, POLYFLOW.....Having some generality within its application range.

General code(通用程序): HT, FF, Combustion, MT, Reaction, Thermal radiation, etc.; PHOENICS, FLUENT, CFX, STAR-CD ,

Different codes tempt to have some generality(通用性) .

Generality includes: Coordinates; G.E.; B.C. treatment; Source term treatment; Geometry.....

2. General governing equations of 1-D steady heat conduction problem

$$\frac{1}{A(x)} \frac{d}{dx} \left[\lambda A(x) \frac{dT}{dx} \right] + S = 0$$

T ----Temperature;

x ----Independent space variable (独立空间变量),
normal to cross section;

$A(x)$ ----Area factor, normal to heat conduction
direction;

λ ----Thermal conductivity;

S ---- Source term, may be a function of both x and T .

$$\frac{1}{A(x)} \frac{d}{dx} \left[\lambda A(x) \frac{dT}{dx} \right] + S = 0$$

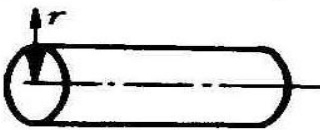
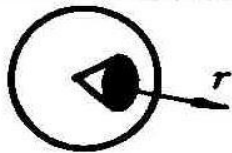
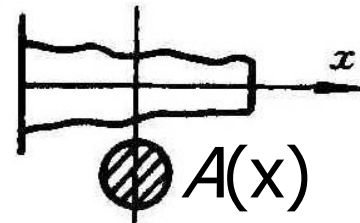
Mode	Coordinate	Indep. variable	Area factor	Illustration (图示)
1	Cartesian	x	1(unit)	
2	Cylindrical	r	r (arc 弧度 area)	
3	Spherical	r	r ² (spherical surface)	
4	Variable cross section	x Perpendicular to section	A(x), ⊥ Heat conduction direction	



3.1.2 Discretization of Gener. Govern .Eq. by CVM

Multiplying two sides by $A(x)$

$$\frac{1}{A(x)} \frac{d}{dx} \left[\lambda A(x) \frac{dT}{dx} \right] + S = 0 \quad \longrightarrow \quad \frac{d}{dx} \left[\lambda A(x) \frac{dT}{dx} \right] + S \cdot A(x) = 0$$

Linearizing (线性化) source term : $S(x, T) \cong S_C + S_P T_P$

S_C and S_P are constant in the CV.

Adopting piecewise linear profile for temperature;

Integrating over control volume P yielding (得)

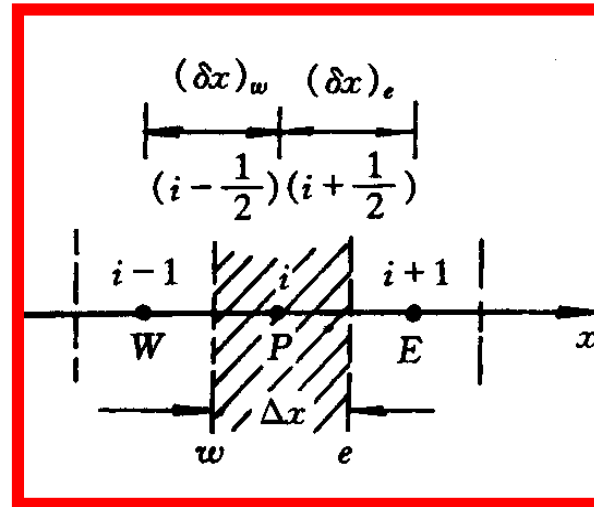

$$\left[\lambda A(x) \frac{dT}{dx} \right]_e - \left[\lambda A(x) \frac{dT}{dx} \right]_w + \int (S_C + S_P T_P) A(x) dx = 0$$

Using the piecewise linear profile for temperature:

$$\lambda_e A_e(x) \frac{T_E - T_P}{(\delta x)_e} - \lambda_w A_w(x) \frac{T_P - T_W}{(\delta x)_w} + (S_C + S_P T_P) \cdot A_P(x) \cdot \Delta x = 0$$

Moving terms with T_P to left side while those with T_E, T_W to right side

$$T_P \left[\frac{A_e(x)\lambda_e}{(\delta x)_e} + \frac{A_w(x)\lambda_w}{(\delta x)_w} - S_P A_P(x)\Delta x \right] = T_E \left[\frac{A_e(x)\lambda_e}{(\delta x)_e} \right] + T_W \left[\frac{A_w(x)\lambda_w}{(\delta x)_w} \right] + S_C A_P(x)\Delta x$$

We adopt following well-accepted form for discretized eqs.:

$$a_P T_P = a_E T_E + a_W T_W + b$$

$$a_E = \frac{\lambda_e A(x)_e}{(\delta x)_e}, \quad a_W = \frac{\lambda_w A(x)_w}{(\delta x)_w}, \quad b = S_C A_P(x)\Delta x = S_C \Delta V$$

$$a_P = a_E + a_W - S_P \Delta V$$

Physical meaning of coefficients a_E, a_W

$$a_E = \frac{1}{(\delta x)_e / [\lambda_e A(x)_e]} = \frac{1}{\text{Thermal resistance between P and E}}$$

a_E is the reciprocal(倒数) of thermal conduction resistance between Points P and E. It represents the effect of the temperature of point E on point P, and is called influencing coefficient(影响系数) --- **Physical meaning!**

3.1.3 Determination of interface thermal conductivity

1. Arithmetic mean (算术平均法)

$$\lambda_e = \lambda_P \frac{(\delta x)_{e^+}}{(\delta x)_e} + \lambda_E \frac{(\delta x)_{e^-}}{(\delta x)_e}$$

Uniform grid



$$\lambda_e = \frac{\lambda_P + \lambda_E}{2}$$

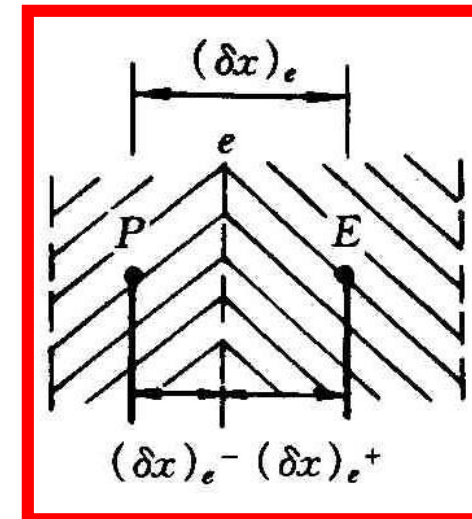

2. Harmonic mean (调和平均法)

Assuming that conductivities of P , E are different, according to the continuum requirement of heat flux (热流密度的连续性要求) at interface e

$$\frac{T_E - T_e}{(\delta x)_{e^+}} = \frac{T_e - T_P}{(\delta x)_{e^-}} \rightarrow \frac{T_E - T_P}{(\delta x)_{e^+} + (\delta x)_{e^-}}$$

Left side

Right side

Algebraic operation rule

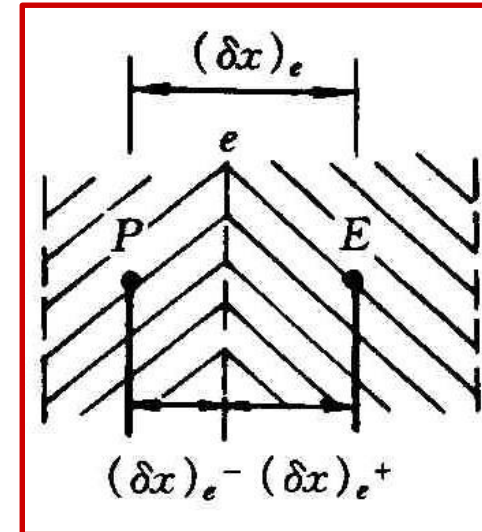

$$\frac{T_E - T_P}{(\delta x)_{e^+} + (\delta x)_{e^-}} = \frac{T_E - T_P}{(\delta x)_e}$$

Interface conductivity

$$\frac{(\delta x)_e}{\lambda_e} = \frac{(\delta x)_{e^+}}{\lambda_E} + \frac{(\delta x)_{e^-}}{\lambda_P}$$

Harmonic mean

For uniform grid:

$$\lambda_e = \frac{2\lambda_P\lambda_E}{\lambda_P + \lambda_E}$$

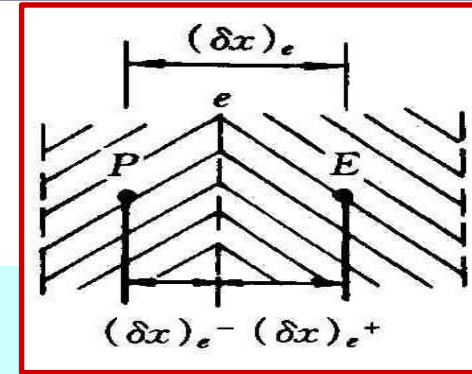

3. Comparison of two methods

If $\lambda_P \gg \lambda_E$ major resistance is at E -side, while the arithmetic mean yields:

$$\lambda_e = \frac{\lambda_P + \lambda_E}{2} \xrightarrow{\lambda_P \gg \lambda_E} \lambda_e \cong \frac{\lambda_P}{2} \xrightarrow{\text{Resis.}} \frac{(\delta x)_e}{\frac{\lambda_P}{2}}$$

From harmonic mean:

$$\lambda_e = \frac{2\lambda_E\lambda_P}{\lambda_E + \lambda_P} \xrightarrow{\lambda_P \gg \lambda_E} \lambda_e \cong 2\lambda_E \xrightarrow{\text{Resis.}} \frac{(\delta x)_e}{2\lambda_E} \xrightarrow{\text{Uniform}} \frac{(\delta x)_e}{\lambda_E} \text{ Reasonable!}$$

Harmonic mean has been widely accepted.

3.1.4 Discretization of 1-D transient heat conduction equation

1. Governing eq.
$$\rho c \frac{\partial T}{\partial t} = \frac{1}{A(x)} \frac{d}{dx} \left[\lambda A(x) \frac{dT}{dx} \right] + S$$

2. Integration over CV Multiplying by $A(x)$, and

Assuming ρc is independent on time, integrating over CV P within time step Δt

$$(\rho c)_P A_P(x) \Delta x (T_P^{n+1} - T_P^n) = \int_t^{t+\Delta t} \left[\frac{\lambda_e A_e(x) (T_E - T_P)}{(\delta x)_e} - \frac{\lambda_w A_w(x) (T_P - T_W)}{(\delta x)_w} \right] dt$$

Stepwise in space

Needs to select time profile

$$+ \Delta x A_P(x) \int_t^{t+\Delta t} (S_C + S_P T_P) dt$$

Key Points of Last lecture

1. Discretization of governing equation (GE.) by FDM:

Replacing the 1st-order and 2nd-order derivatives in the governing equation by their corresponding finite difference forms.

2. Discretization of GE. By FVM:

Integrating the conservative GE. for a CV, selecting the profiles for the variable and its 1st-order derivative and completing the integration.

3. A well-accepted form of 1D discretized heat conduction eqs. :

$$a_P T_P = a_E T_E + a_W T_W + b \quad a_E = \frac{1}{\text{Thermal resistance between P and E}}$$

4. Harmonic mean of interface conductivity

$$\frac{(\delta x)_e}{\lambda_e} = \frac{(\delta x)_{e^+}}{\lambda_E} + \frac{(\delta x)_{e^-}}{\lambda_P}$$

3. Results with a general time profile of temperature

$$\int_t^{t+\Delta t} T dt = [f T^{t+\Delta t} + (1-f)T^t] \Delta t = [f T + (1-f)T^0] \Delta t, \quad 0 \leq f \leq 1$$

Substituting this profile, integrating, yields:

$$a_P T_P = a_E [f T_E + (1-f)T_E^0] + a_W [f T_W + (1-f)T_W^0] + T_P^0 \left[\frac{a_P^0 - (1-f)a_E - (1-f)a_W + (1-f)S_P A_P(x) \Delta x}{a_t} + \frac{S_C A_P(x) \Delta x}{b} \right]$$

$$a_P T_P = a_E T_E^f + a_W T_W^f + a_t T_P^0 + b$$

$$a_E = \frac{\lambda_e A_e(x)}{(\delta x)_e} = \frac{A_e(x)}{\frac{(\delta x)_{e^+}}{\lambda_E} + \frac{(\delta x)_{e^-}}{\lambda_P}}$$

$$a_P = f a_E + f a_W + a_P^0 - f S_P A_P(x) \Delta x$$

$$a_W = \frac{\lambda_w A_w(x)}{(\delta x)_w} = \frac{A_w(x)}{\frac{(\delta x)_{w^+}}{\lambda_P} + \frac{(\delta x)_{w^-}}{\lambda_W}}$$

$$a_P^0 = \frac{\rho c A_P(x) \Delta x}{\Delta t} = \frac{\rho c \Delta V}{\Delta t}$$

Thermal inertia
(热惯性)

4. Three forms of time level for discretized diffusion term

(1) Explicit(显), $f = 0$;
$$\frac{T_P - T_P^0}{\Delta t} = a \left(\frac{T_E^0 - 2T_P^0 + T_W^0}{\Delta x^2} \right)$$

(2) Fully implicit(全隐) , $f = 1$;

$$\frac{T_P - T_P^0}{\Delta t} = a \left(\frac{T_E - 2T_P + T_W}{\Delta x^2} \right)$$

(3) C-N scheme, $f = 0.5$

$$\frac{T_P - T_P^0}{\Delta t} = \frac{a}{2} \left(\frac{T_E - 2T_P + T_W}{\Delta x^2} + \frac{T_E^0 - 2T_P^0 + T_W^0}{\Delta x^2} \right)$$

No subscript for $(t + \Delta t)$ time level for convenience.

3.1.5 Only fully implicit scheme can guarantee physically meaningful solution

Illustrated by an example.

[Known] 1-D transient HC without source term, uniform initial field. Two surfaces were suddenly cooled down to zero.

[Find] Variation of inner point temperature with time

[Solution] Discretized by Practice A
Adopting three grids: W, P, and E.

Physically the variation trend shown in right fig. can be expected!

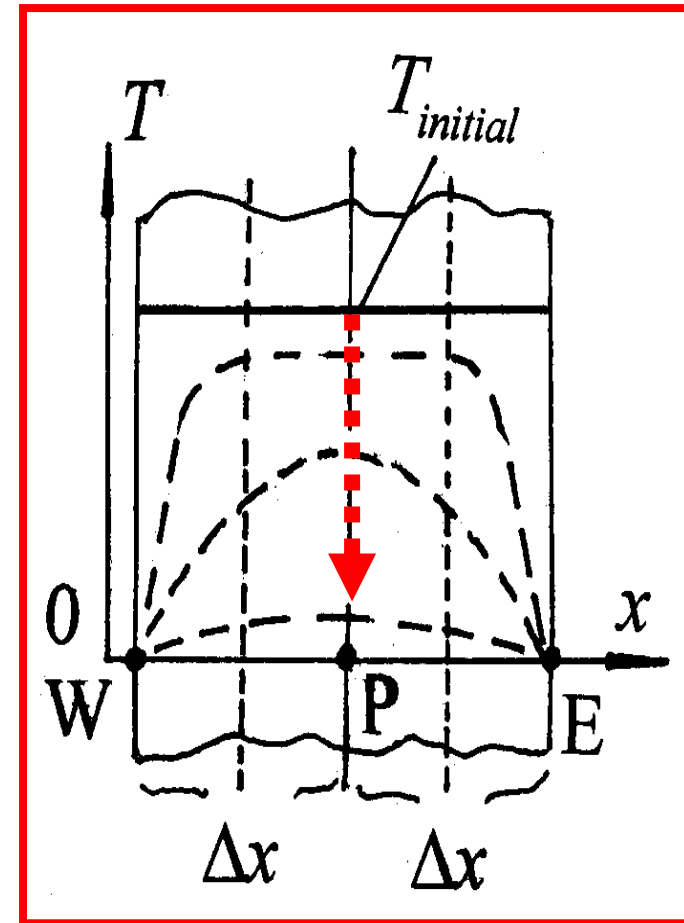

Analyzing the 2nd time level:

$$T_E = T_E^0 = T_W = T_W^0 = 0 ; S_C = 0, S_P = 0 \quad \text{Substituting:}$$

$$a_P T_P = a_E [f T_E^0 + (1-f) T_E^0] + a_W [f T_W^0 + (1-f) T_W^0] +$$

$$T_P^0 [a_P^0 - (1-f)a_E - (1-f)a_W + (1-f)S_P A_P(x)\Delta x] + S_C A_P(x)\Delta x$$

Yields $a_P T_P = T_P^0 [a_P^0 - (1-f)a_E - (1-f)a_W]$

i.e.: $\frac{T_P}{T_P^0} = \frac{a_P^0 - (1-f)(a_W + a_E)}{a_P} = \frac{a_P^0 - (1-f)(a_W + a_E)}{a_P^0 + f(a_W + a_E)}$

$$a_E = a_W = \frac{\lambda \bullet 1}{\Delta x}, a_P^0 = \frac{\rho c_p \Delta x}{\Delta t}, \frac{a_E}{a_P^0} = \frac{\lambda / \Delta x}{\rho c_p \Delta x / \Delta t} = \left(\frac{\lambda}{\rho c_p}\right) \frac{\Delta t}{\Delta x^2} = \frac{a \Delta t}{\Delta x^2}$$

Finally: $\frac{T_P}{T_P^0} = \frac{1 - 2(1-f)\left(\frac{a \Delta t}{\Delta x^2}\right)}{1 + 2f\left(\frac{a \Delta t}{\Delta x^2}\right)}$

$$\frac{a \Delta t}{\Delta x^2} = Fo_{\Delta}$$

Grid Fourier number!

$$\frac{T_P}{T_P^0} = \frac{1 - 2(1-f)Fo_\Delta}{1 + 2fFo_\Delta}$$

Physically it is required :

$$\frac{T_P}{T_P^0} > 0$$

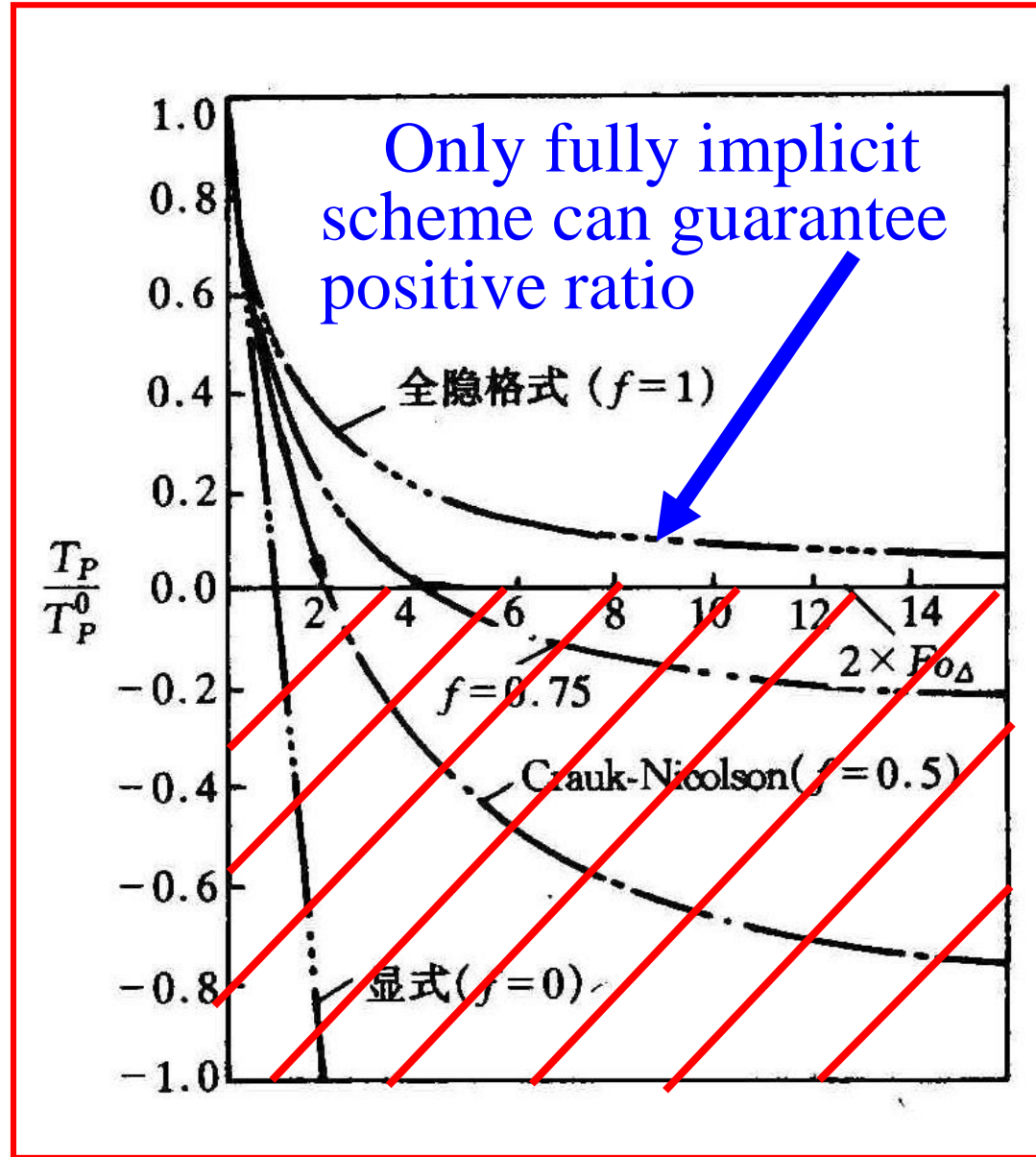
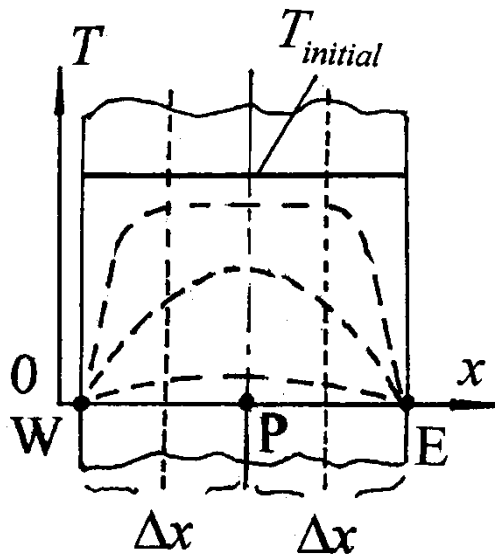

Only when $f = 1$ (fully imp.) can guarantee it!

This result can be obtained from physical analysis!

The discretized form of transient HC is:

$$a_P T_P = a_E T_E^f + a_W T_W^f + a_t T_P^0 + b \left(\frac{\partial \theta}{\partial Y} \right)_0$$

physically all coefficients must by ≥ 0 :

$$a_t = a_P^0 - (1-f)a_E - (1-f)a_W \geq 0$$

$$1 - (1-f)(a_E + a_W) / a_P^0 \geq 0$$

$$\frac{a_E}{a_P^0} = \frac{a \Delta t}{\Delta x^2} = Fo_{\Delta}$$

$$Fo_{\Delta} \leq \frac{1}{2(1-f)}$$

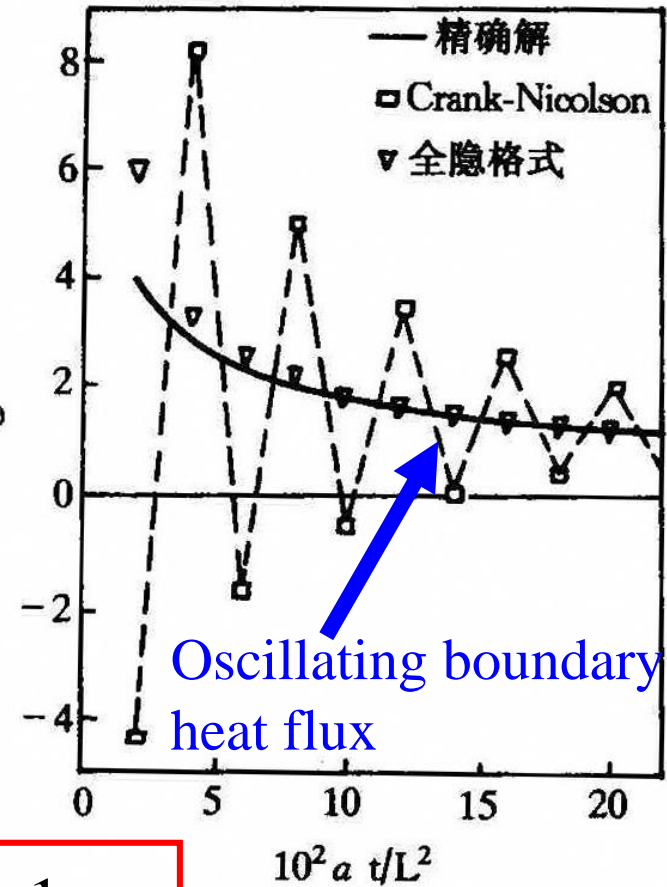

Conclusion: Only fully implicit scheme can always guarantee solution physically meaningful!

3.2 Fully Implicit Scheme of Multi-dimensional Heat Conduction Equation

3.2.1 Fully implicit scheme in three coordinates

3.2.2 Comparison between coefficients

3.2.3 Uniform expression of discretized form for three coordinates

3.2 Fully Implicit Scheme of Multi-dimensional Heat Conduction Equation

3.2.1 Fully implicit scheme in three coordinates

1. Cartesian coordinates

(1) Governing eq.

$$\rho c \frac{\partial T}{\partial t} = \frac{\partial}{\partial x} \left(\lambda \frac{\partial T}{\partial x} \right) + \frac{\partial}{\partial y} \left(\lambda \frac{\partial T}{\partial y} \right) + S$$

(2) CV integration

Space profiles are the same as 1-D problem.

Fully implicit for time

Heat flux is locally uniform at interface.

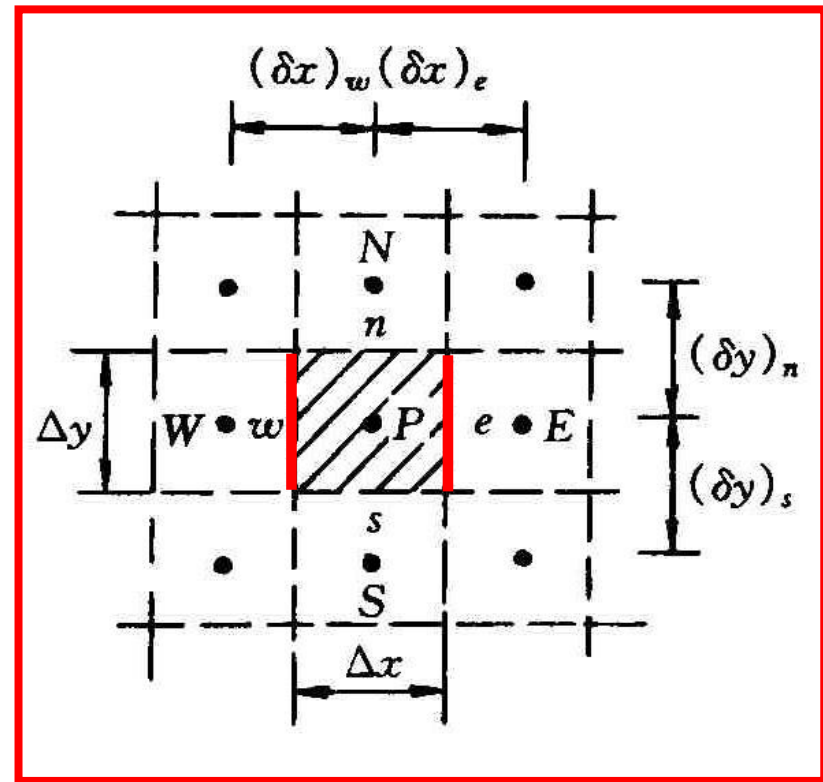

Integration of transient term =

$$\int_s^n \int_w^e \int_t^{t+\Delta t} \rho c \frac{\partial T}{\partial t} dx dy dt \xrightarrow{\text{stepwise}} (\rho c)_P (T_P - T_P^0) \Delta x \Delta y$$

Diffusion term (1) =

$$\int_s^n \int_w^e \int_t^{t+\Delta t} \frac{\partial}{\partial x} \left(\lambda \frac{\partial T}{\partial x} \right) dx dy dt =$$

$$\int_s^n \int_t^{t+\Delta t} \left[\left(\lambda \frac{\partial T}{\partial x} \right)_e - \left(\lambda \frac{\partial T}{\partial x} \right)_w \right] dy dt$$

Space linear-wise
 Heat flux uniform,
 Time fully implicit

$$= \left(\lambda_e \frac{T_E - T_P}{(\delta x)_e} - \lambda_w \frac{T_P - T_W}{(\delta x)_w} \right) \Delta y \Delta t$$

No subscript for
 (n+1) time level!

Diffusion term (2) =
$$\int_s^n \int_w^e \int_t^{t+\Delta t} \frac{\partial}{\partial y} \left(\lambda \frac{\partial T}{\partial y} \right) dx dy dt =$$

$$\int_w^e \int_t^{t+\Delta t} \left[\left(\lambda \frac{\partial T}{\partial y} \right)_n - \left(\lambda \frac{\partial T}{\partial y} \right)_s \right] dx dt$$

Space linear wise
 Heat flux uniform,
 Time fully implicit

$$= \left(\lambda_n \frac{T_N - T_P}{(\delta y)_n} - \lambda_s \frac{T_P - T_S}{(\delta y)_s} \right) \Delta x \Delta t$$

Source term =
$$\int_w^e \int_s^n \int_t^{t+\Delta t} S dx dy dt \xrightarrow[\text{Fully implicit}]{\text{Linealization}} (S_C + S_P T_P) \Delta x \Delta y \Delta t$$

Substituting and rearranging:

$$a_P T_P = a_E T_E + a_W T_W + a_N T_N + a_S T_S + b$$

$$a_E = \frac{\Delta y}{(\delta x)_e / \lambda_e}, a_W = \frac{\Delta y}{(\delta x)_w / \lambda_w}, a_N = \frac{\Delta x}{(\delta y)_n / \lambda_n}, a_S = \frac{\Delta x}{(\delta y)_s / \lambda_s}$$

$$a_P = a_E + a_W + a_N + a_S + a_P^0 - S_P \Delta x \Delta y$$

$$a_P^0 = \frac{\rho c \Delta V}{\Delta t}, b = S_C \Delta V + a_P^0 T_P^0$$

Physical meaning of coefficients: reciprocal of thermal conduction resistance, or heat conductance (热导) between neighboring grids.

$$a_E = \frac{\Delta y}{(\delta x)_e / \lambda_e} = \frac{\lambda_e \Delta y}{(\delta x)_e}$$

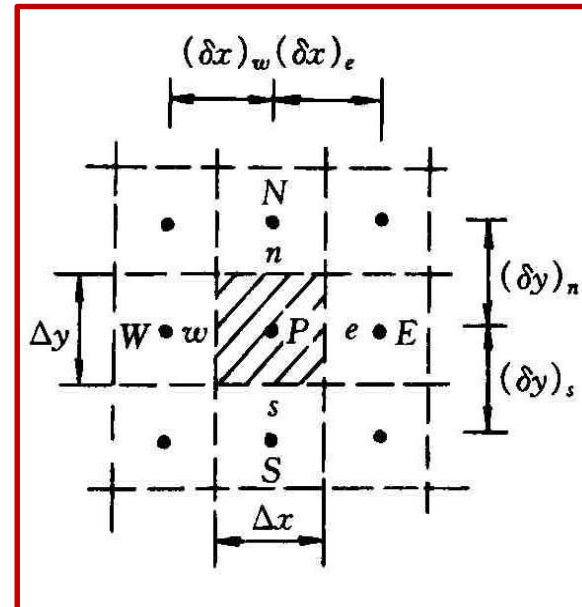

2. 2D Cylindrical coord.

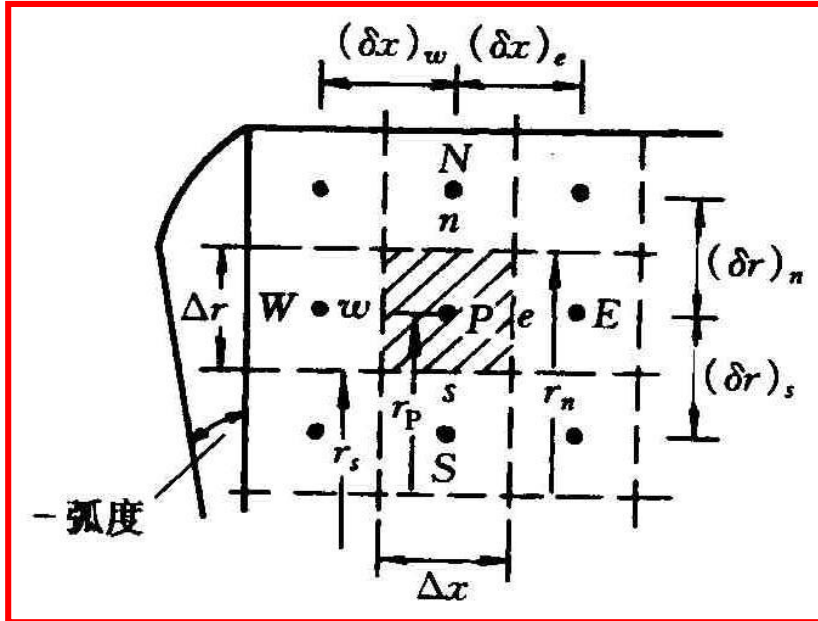
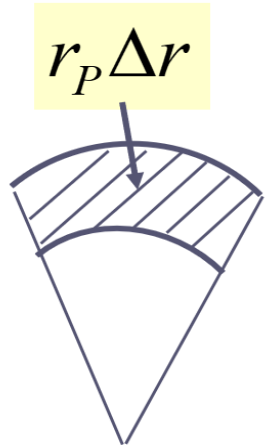

3. Polar coordinates

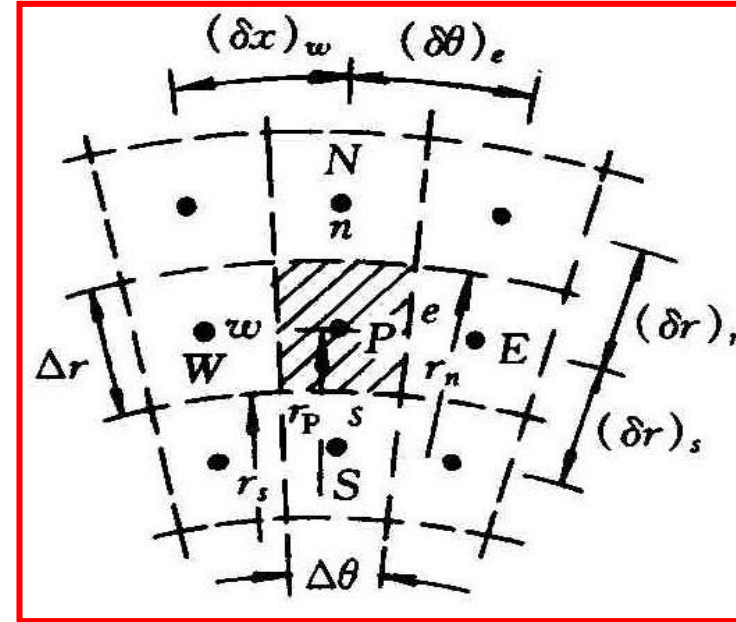

$$a_P T_P = a_E T_E + a_W T_W + a_N T_N + a_S T_S + b$$

$$a_E = \frac{r_P \Delta r}{(\delta x)_e} \lambda_e$$

$$a_E = \frac{\Delta r}{r_P (\delta \theta)_e} \lambda_e$$

3.2.2 Comparison between coefficients

Coefficients a_E of the three 2-D coordinates can be expressed as

$$a_E = \frac{\text{Interface conductivity} \times \text{HC area from P to E}}{\text{Distance between Nodes P and E}}$$

It is the thermal conductance between nodes P and E !

1. What's the difference between three coordinates ?

- (1) In polar coordinate θ is the arc (弧度), dimensionless, while in $x - y, x - r$, x is dimensional!
- (2) In polar and cylindrical coordinates there are radius, while in Cartesian coordinate no any radius at all.

2. One way to unify the expression of coefficients

For this purpose we introduce two auxiliary (辅助的) parameters

(1) **Scaling factor in x-direction** (x-方向标尺因子)

Distance in x direction is expressed by $s_x \bullet \delta x$

For Cartesian and cylindrical coordinates: $s_x \equiv 1$;

For polar coordinate: $s_x = r$;

(2) In y-direction, a **normal**(名义上的) **radius**, R , is introduced.

For Cartesian coordi. $R = 1$ For Cy. & Po. $R = r$

Then: W-E conduction distance: $s_x \bullet \delta x$ $\left\{ \begin{array}{l} \Delta y \text{ ---- Cartesian} \\ R \Delta r \text{ ---- Cylindrical} \\ \Delta r \text{ ---- Polar} \end{array} \right.$

W-E conduction area: $R \Delta y / s_x$

3.2.3 Unified expressions for three 2-D coordinates

Coordinate	Cartes.	Cy.Sym	Polar	Generalized
W-E Coord.	x	x	θ	X
S-N Coord.	y	r	r	Y
Radius	1	r	r	R
Scaling factor in x	1	1	r	SX
E-W distance	δx	δx	$r\delta\theta$	$(\delta x)(SX)$
S-N distance	δy	δr	δr	δY
W-E area of conduction	Δy	$r\Delta r$	Δr	$R\Delta Y / SX$

S-N area of conduction	Δx	$r\Delta x$	$r\delta\theta$	$R(\Delta X)$
Volume of CV	$\Delta x\Delta y$	$r\Delta x\Delta r$	$r\Delta\theta\Delta r$	$R\Delta X\Delta Y$
a_E	$\frac{\Delta y}{(\Delta x)_e / \lambda_e}$	$\frac{r\Delta r}{(\Delta x)_e / \lambda_e}$	$\frac{\Delta r}{(\Delta\theta)_e r / \lambda_e}$	$\frac{R\Delta Y}{(SX)^2 (\Delta X)_e / \lambda_e}$
a_N	$\frac{\Delta x}{(\Delta y)_n / \lambda_n}$	$\frac{r\Delta x}{(\Delta r)_n / \lambda_n}$	$\frac{r\Delta\theta}{(\Delta r)_n / \lambda_n}$	$\frac{R\Delta X}{(\delta Y)_n / \lambda_n}$
a_P^0	$\rho c R \Delta X \Delta Y / \Delta t$			
b	$S_c R \Delta X \Delta Y$			

If coding by this way, then by setting up a variable, MODE, computer will automatically deal with the three coordinates according to MODE:

In our teaching code, it is set up as follows :

MODE	1(x-y)	2(x-r)	3(theta-r)
R	1	r	r
SX	1	1	r

Commercial software usually adopts the similar method to deal with coefficients in different different coordinates.

3.3 Treatments of Source Term and B.C.

3.3.1 Linearization of non-constant source term

1. Linearization (线性化) method
2. Discussion
3. Examples of linearization method

3.3.2 Treatments of 2nd and 3rd kind of B.C. for closing algebraic equations

1. Supplementing (补充) equations for boundary points
2. Additional source term method (ASTM)

3.3 Treatments of Source Term and B.C.

3.3.1 Linearization of non-constant source term

1. Linearization (线性化)

Importance of source term in the present method----
”Ministry of **portfolio** (不管部长)”：refer to (指) any terms which can not be classified as one of the transient, diffusion or convection terms.

Linearization: for CV P its source term is expressed as:

$$S = S_C + S_P \phi_P, S_P \leq 0$$

S_C, S_P are constants for each CV, S_P is the slope(斜率) of the curve $S = f(\phi)$

For the curve $S = f(T)$

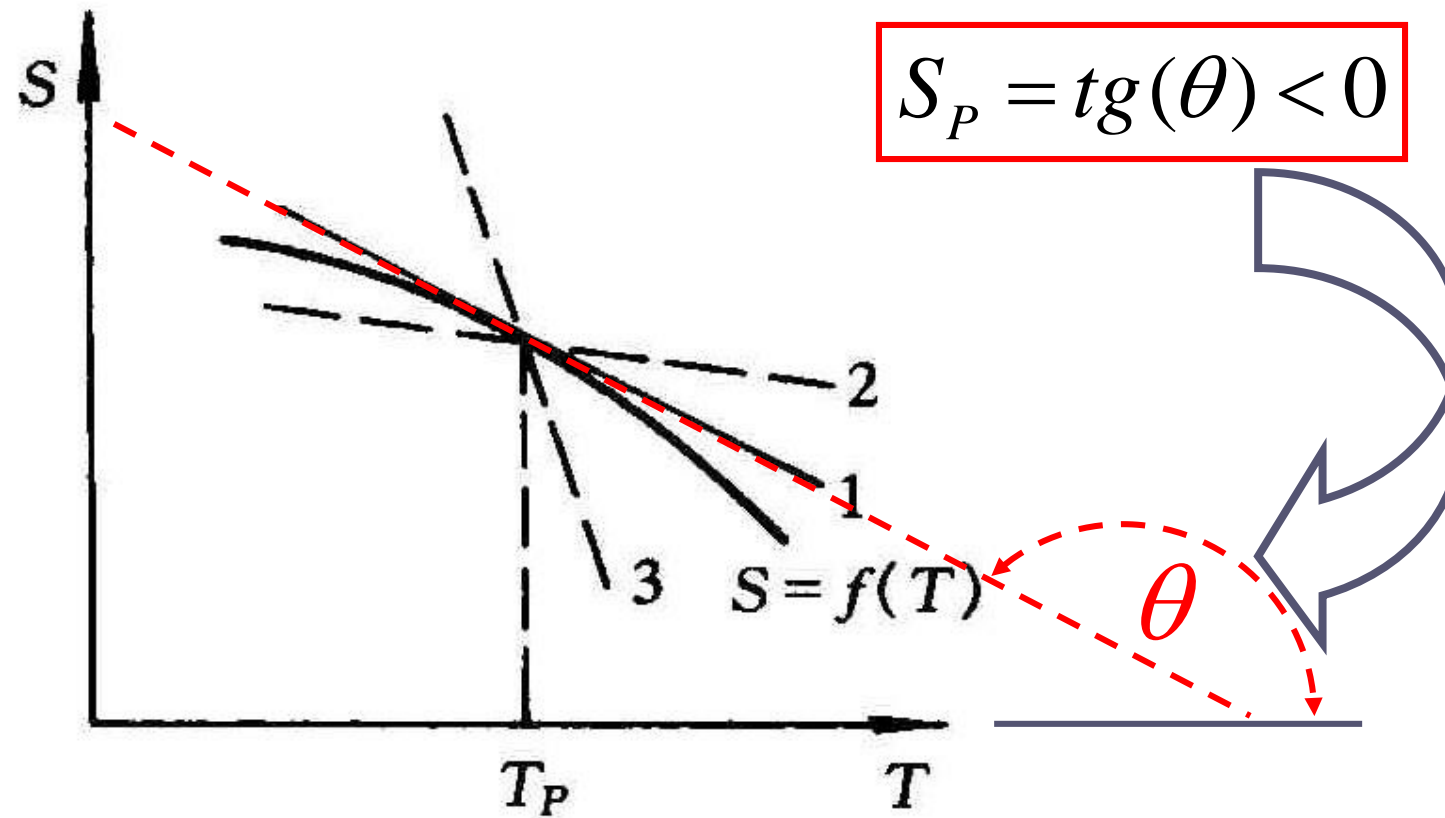

2. Discussion on linearization of source term

- (1) For variable source term , $S = f(T)$, **linearization is better than taking previous value, $S = f(T_P^*)$.**

There is one time step lag (迟后) between

$$S = S_C + S_P T_P \text{ and } S = f(T^*) .$$

- (2) Any complicated function can be approximated by a linear function, **and linearity is also required for deriving linear algebraic equations.**
- (3) **$S_P \leq 0$ is required by the convergence condition for solving the algebraic equations.**

The **sufficient condition** for obtaining converged solution by iterative method for the algebraic equations like:

$$a_P \phi_P = \sum a_{nb} \phi_{nb} + b$$

is that: $a_P \geq \sum a_{nb}$

Since in our method:

$$a_P = \sum a_{nb} - S_P \Delta V$$

Thus $S_P \leq 0$ will ensure(确保) the above sufficient condition.

- (4) If a practical problem has $S_p > 0$, then
 an artificial(人为的) negative S_p may be introduced.
- (5) Effect of the absolute value of S_p on the convergence speed

Iteration equation:
$$\phi_P = \frac{\sum a_{nb} \phi_{nb} + b}{\sum a_{nb} - S_p \Delta V}$$

$|S_p|$ ↑ Denominator(分母) increases, difference between two successive (相继的) iterations decreases; hence convergence speed decreases;

With given iteration number, it is favorable (利于) to get the converged solution for highly nonlinear problem.

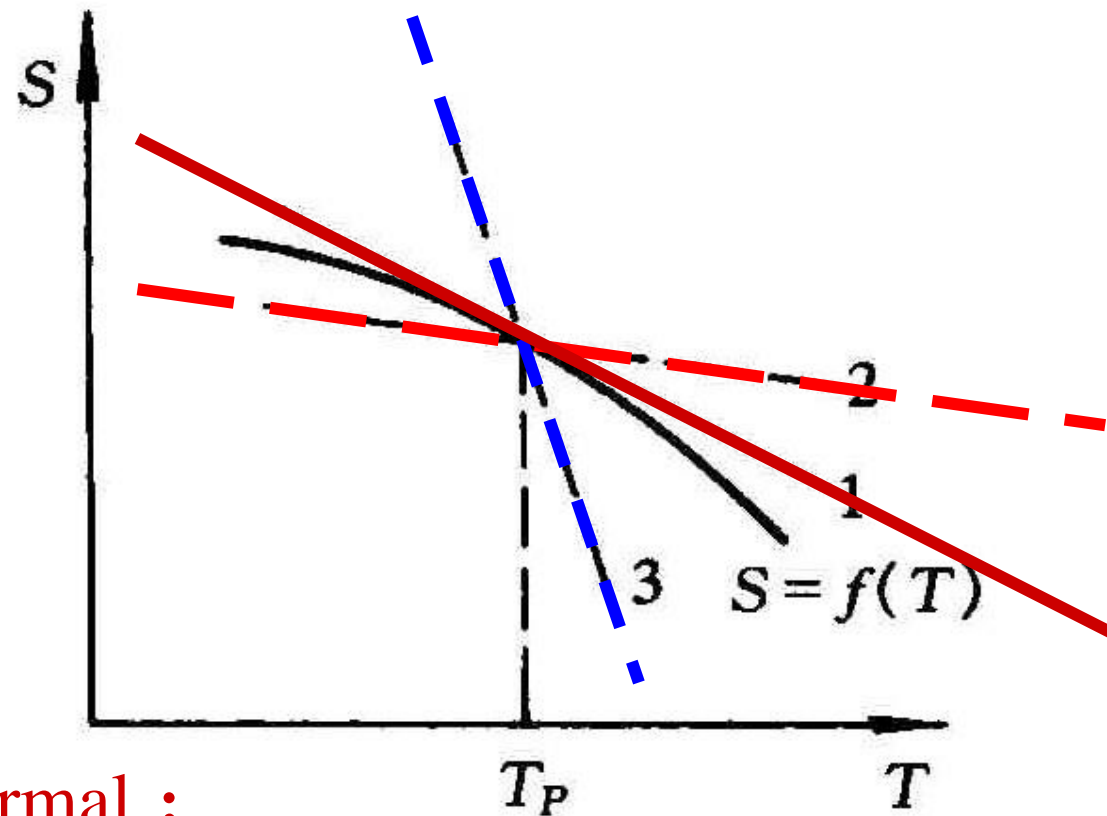

Curve 1-- normal ;

Curve 3-- Absolute value of S_p increases — It is in favor of getting a converged solution for nonlinear case, while **speed of convergence decreases.**

Curve 2 -- Absolute value of S_p decreases, it is in favor of speed up iteration, but **takes a risk(风险) of divergence!**

3. Examples of linearization

(1) $S = 3 - 5T$; $S_C = 3$, $S_P = -5$

(2) $S = 3 + 5T$;

Different practices:

$$\left\{ \begin{array}{l} S_C = 3 + 5T^*, S_P = 0 \\ S_C = 3 + 7T^*, S_P = -2 \\ \dots\dots\dots \end{array} \right.$$

(3) $S = 4 - 2T^2$;

$$S = S^* + \left(\frac{dS}{dT}\right)^* (T - T^*) = [4 - (2T^*)^2] + (-4T^*)(T - T^*)$$

$$= 4 - 2T^{*2} + 4T^{*2} - 4T^*T = \underbrace{4 + 2T^{*2}}_{S_C} - \underbrace{4T^*T}_{S_P}$$

Recommended

3.3.2 Treatments of 2nd and 3rd kind of B.C. for closing algebraic equations

For 2nd and 3rd kinds of B.C., the boundary temperatures are not known, while they are involved in the inner node equations. Thus the resulted algebraic equations are not closed (方程组不封闭).

1. Supplementing (增补) equations for boundary nodes.

Adopting balance method to obtain boundary node eq.

(1) Practice A

Taking the heat into the solution region as positive.

$$q_B + \lambda \frac{T_{M_1-1} - T_{M_1}}{\delta x} + \Delta x \cdot S = 0$$

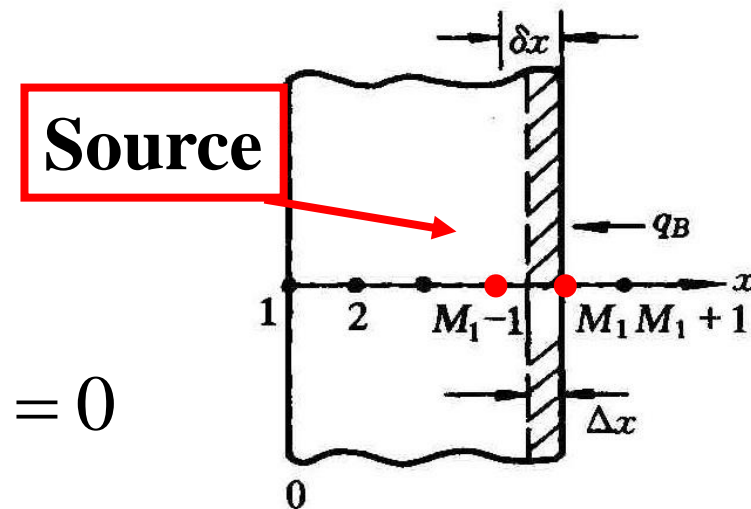

Yields:
$$T_{M1} = T_{M1-1} + \frac{\delta x \cdot \Delta x \cdot S}{\lambda} + \frac{q_B \cdot \delta x}{\lambda}$$

The T.E. of this discretized equation is: $O(\Delta x^2)$

For 3rd kind B.C., according to Newton's law of cooling:

$$q_B = h(T_f - T_{M1}) \quad (\text{Heat into the region as } +)$$

Substituting q_B into the above equation, and rearranging:

$$T_{M1} = \frac{T_{M1-1} + \frac{\delta x \cdot \Delta x \cdot S}{\lambda} + \left(\frac{h \cdot \delta x}{\lambda}\right)T_f}{\frac{h \cdot \delta x}{\lambda} + 1}$$

(2) Practice B

The **volume of boundary node in Practice B is zero**, thus setting zero volume of the boundary nodes in the above two equations:

$$q_B + \lambda \frac{T_{M1-1} - T_{M1}}{\delta x} + \Delta x \bullet S = 0$$

yields:

for 2nd kind boundary —

$$T_{M1} = T_{M1-1} + \frac{q_B \bullet \delta x}{\lambda}$$

for 3rd kind boundary —

$$T_{M1} = \frac{T_{M1-1} + \left(\frac{h \bullet \delta x}{\lambda}\right) T_f}{1 + \frac{h \bullet \delta x}{\lambda}}$$

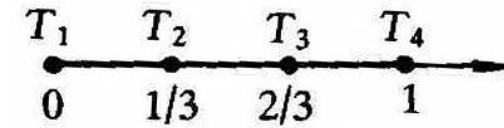

(a)

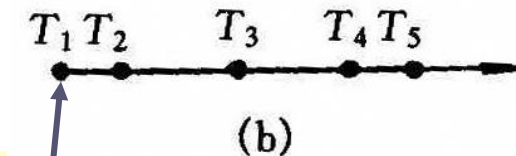

(b)

Zero boundary CV

The above discretized forms have 2nd order accuracy.

(3) Example 4-4 (in Textbook)

[Known] $d^2T/dx^2 - T = 0$; $x = 0, T = 0$; $x = 1, dT/dx = 1$

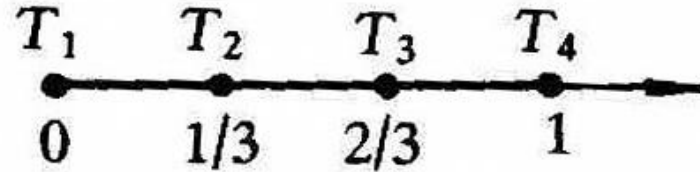

[Find] Temperatures of 2-3 nodes in the region

[Solution]

This is a heat conduction problem with a source term ($-T$);

Practice A, 2 inner nodes,

T_2, T_3 : Adopting 2nd-order accuracy discretization eq.

T_4 : Adopting 1st order , $(T_4 - T_3)/(1/3) = 1 \longrightarrow T_4 - T_3 = 1/3$

T_4 : Adopting 2nd order: $T_{M1} = T_{M1-1} + \frac{\delta x \cdot \Delta x \cdot S}{\lambda} + \frac{q_B \cdot \delta x}{\lambda}$

Question 1: What is the source term?

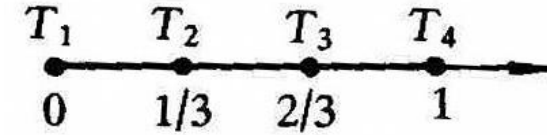

From $\frac{d^2T}{dx^2} - T = 0$ For Point 4: $S = -T_4$

Question 2: What is the boundary heat flux?

$q = \lambda \frac{dT}{dx} = 1 \times 1 = 1$ Then from $T_{M1} = T_{M1-1} + \frac{\delta x \cdot \Delta x \cdot S}{\lambda} + \frac{q_B \cdot \delta x}{\lambda}$

We have $T_4 = T_3 - \frac{\frac{1}{3} \cdot \frac{1}{6} \cdot T_4}{1} + \frac{1 \cdot \frac{1}{3}}{1} \rightarrow \frac{19}{18} T_4 - T_3 = \frac{1}{3}$

Effect of order of accuracy of B.C. on the numerical solution

Scheme	T_2	T_3	T_4
Analytical	0.2200	0.4648	0.7616
T_4 First order	0.2477	0.5229	0.8563
T_4 2nd order	0.2164	0.4570	0.7408

Practice B, three CVs, three inner nodes

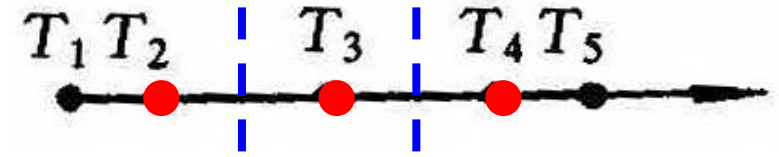

For inner nodes T_2, T_3, T_4 adopting 2nd order; For T_2 :

$$a_E = \frac{\Delta y}{(\delta x)_e / \lambda_e}; \quad a_W = \frac{\Delta y}{(\delta x)_w / \lambda_w}$$

The west interface coincides with the west boundary and $(\delta x)_w$ takes distance between 1 and 2

This is the case of non-uniform grid. a_e can be conveniently determined by the above method.

T_5 can be calculated from $T_{M1} = T_{M1-1} + q_B \cdot \delta x / \lambda$

Numerical results are much closer to exact solution!

Scheme	T_2	T_3	T_4	T_5
Exact	0.1085	0.33377	0.6408	0.7616
Practice B	0.1084	0.33372	0.6035	0.7702

2. Additional source term method (ASTM 附加源项法)

(1) Basic idea

Regarding the heat going into the region by 2nd or 3rd kind B.C. as the **source term** of the first inner CV; Cutting the connection between inner node and boundary, i.e, regarding the boundary as adiabatic, hence eliminating (消除) the wall temp. from discretized eqs. of inner nodes.

(2) Analysis for 2nd kind B.C.

$$a_P T_P = a_E T_E + a_W T_W + a_N T_N + a_S T_S + b$$

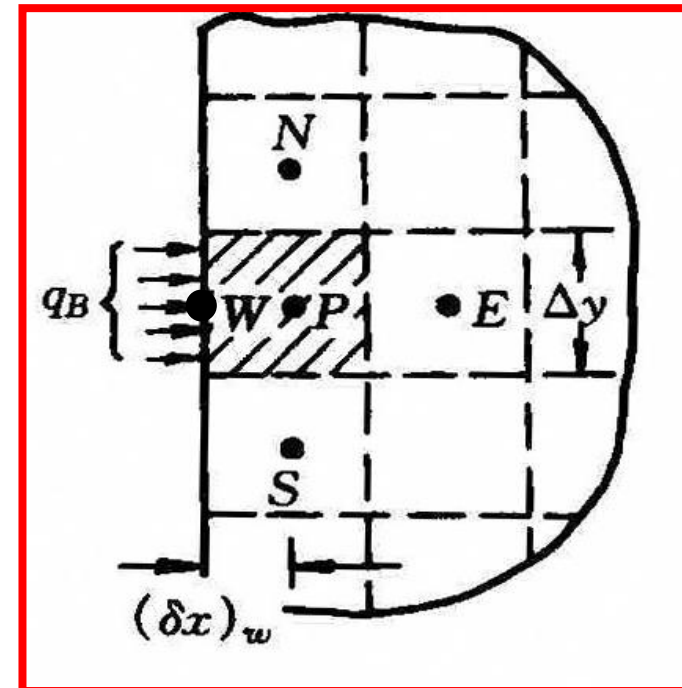

where $a_W = \frac{\lambda_B \Delta y}{(\delta x)_B}$. Subtracting $a_W T_P$ from above eq.

$$\overbrace{a_P}' T_P = a_E T_E + a_N T_N + a_S T_S + \underline{a_W (T_W - T_P)} + b$$

$$a_W (T_W - T_P) = \Delta y \frac{\lambda_B (T_W - T_P)}{(\delta x)_B} = q_B \Delta y \text{ (entering as +)}$$

$$\overbrace{a_P}' T_P = a_E T_E + a_N T_N + a_S T_S +$$

$$\frac{q_B \Delta y}{\Delta V} \Delta V + S_C \Delta V$$

The term $a_W T_W$ is disappeared!

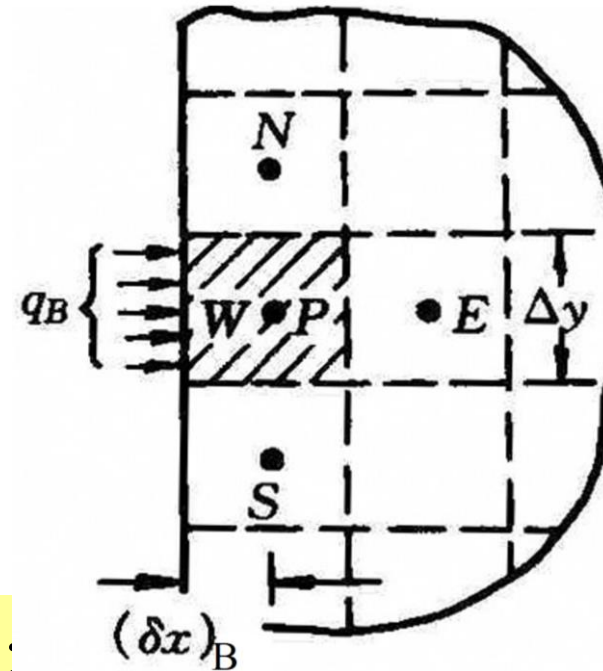

Summary of ASTM for 2nd kind B.C.

- (1) Adding a source term in discretized eq. $S_{C,ad} = \frac{q_B \Delta y}{\Delta V}$
- (2) Setting the conductivity of boundary node to be zero, leading to: $a_W = 0$, equivalent to an adiabatic boundary cond.
- (3) Discretizing inner nodes as usual.

(3) Analysis for 3rd kind B.C.

$$q_B = h(T_f - T_W) \quad (\text{Entering as } +)$$

$$q_B = \frac{T_f - T_W}{\frac{1}{h}} = \frac{T_W - T_P}{\frac{(\delta x)_B}{\lambda_B}} = \frac{T_f - T_P}{\frac{1}{h} + \frac{(\delta x)_B}{\lambda_B}}$$

Substituting the result to the source term for 2nd kind B.C.,

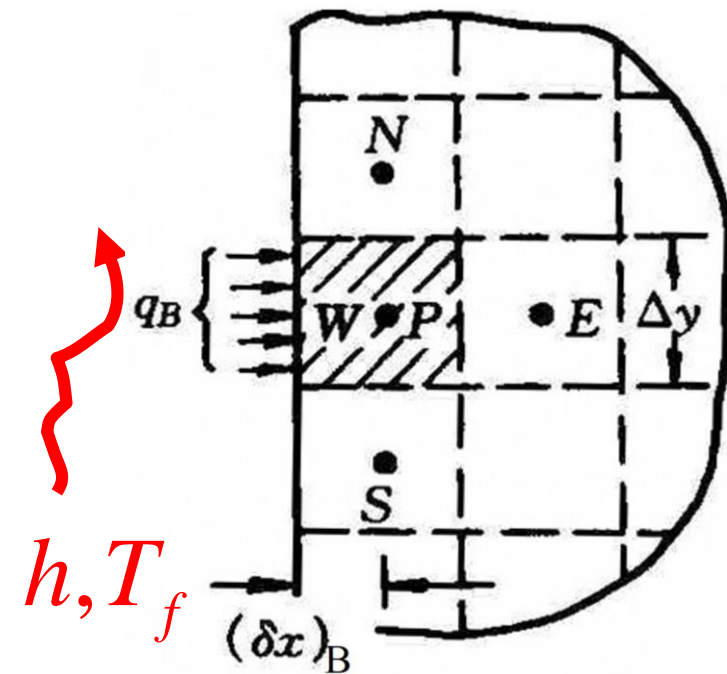

$$a'_P T_P = a_E T_E + a_N T_N + a_S T_S + \frac{q_B \Delta y}{\Delta V} \Delta V + S_C \Delta V$$

$$q_B = \frac{T_f - T_P}{\frac{1}{h} + \frac{(\delta x)_B}{\lambda_B}} \quad \text{Substituting } q_B$$

Moving T_P to left hand, T_f kept as is, yields:

$$\left\{ a'_P + \frac{\Delta y}{\Delta V \bullet [1/h + (\delta x)_B / \lambda_B]} \Delta V \right\} T_P = a_E T_E + a_N T_N + a_S T_S + \left\{ S_C + \frac{\Delta y \bullet T_f}{\Delta V [\frac{1}{h} + \frac{(\delta x)_B}{\lambda_B}]} \right\} \Delta V$$

$$\frac{\Delta y}{\Delta V \bullet [1/h + (\delta x)_B / \lambda_B]} \Delta V = - \frac{-\Delta y}{\Delta V \bullet [1/h + (\delta x)_B / \lambda_B]} \Delta V$$

$$S_{P,ad} = - \frac{\Delta y}{\Delta V \bullet [1/h + (\delta x)_B / \lambda_B]}$$

$$(a_P = a'_P - S_P)$$

$$S_{C,ad} = \frac{\Delta y \bullet T_f}{\Delta V \left[\frac{1}{h} + \frac{(\delta x)_B}{\lambda_B} \right]}$$

(4) Implementing procedure of ASTM

- (a) Determining $S_{C,ad}$, $S_{P,ad}$ for the CV neighboring to the boundary
- (b) Adding them into source term of the related CV by **accumulation**:

$$S_C \leftarrow S_C + S_{C,ad}$$

Accumulative addition
(累加)

- (c) Setting the conductivity of the boundary node to be zero;
- (d) Deriving the discretized eqs. of inner nodes as usual,
Solving the algebraic eqs. for inner nodes;
- (e) Using Newton' law of cooling or Fourier law of heat conduction to get the boundary temperatures from the converged solution of inner nodes.

(5) Application examples of ASTM

In FVM when Practice B is adopted to discretize space, the 2nd and 3rd kinds of B.C. can be treated by ASTM, which can greatly accelerate(加速) the solution process.

Extended applications of ASTM

(1) Dealing with irregular(不规则) boundary

When the code designed for regular region is used to simulated irregular domain, ASTM can be used to treat the B.C.

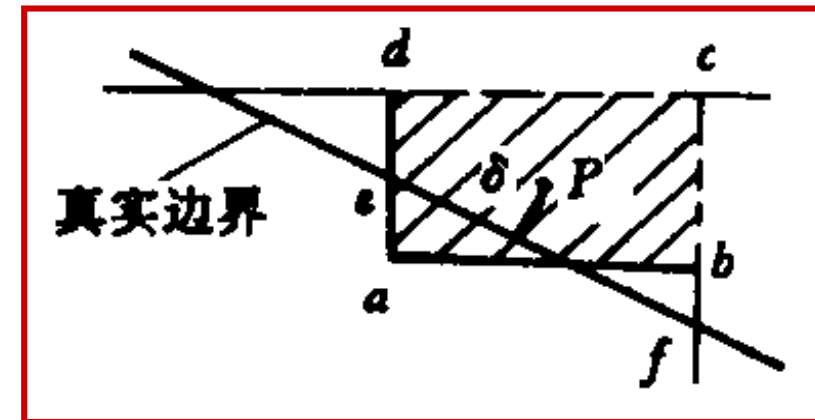
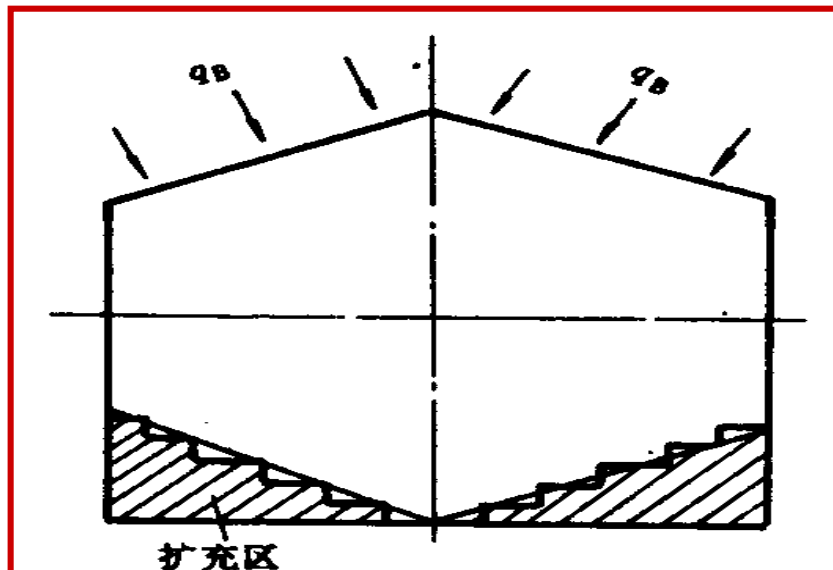

Prata A T. and Sparrow EM. Heat transfer and fluid flow characteristics for an annulus of periodically varying cross section. **Num Heat Transfer, 1984, 7:285-304**

(2) Simulating combined conduction, convection and radiation problem

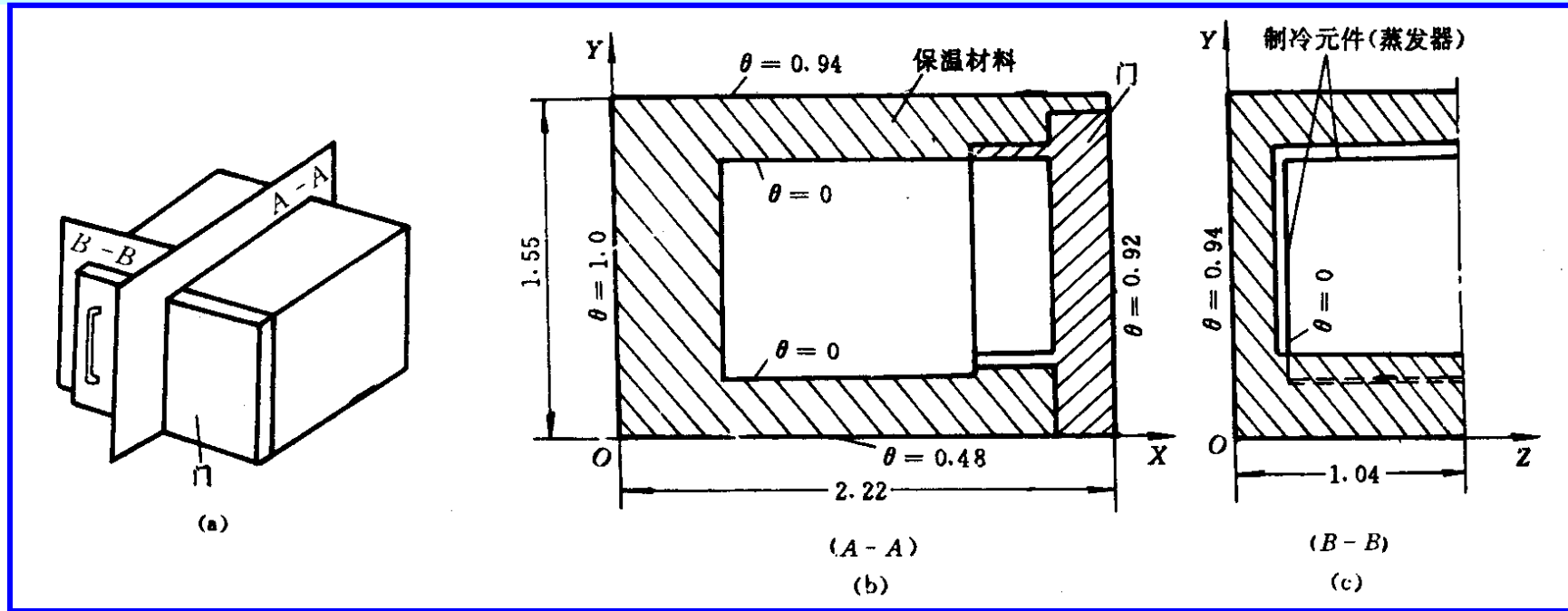

- [1] 陶文铨, 李莞. 处理区域内部导热与辐射联合作用的数值方法. **西安交通大学学报**, 1983, 19 (3) : 65-76
- [2] 杨沫 王育清 傅燕弘 陶文铨. 家用冰箱冷冻冷藏室温度场的数值模拟. **制冷学报**, 1991年, (4):1-8
- [3] Zhao CY, Tao WQ. Natural convections in conjugated single and double enclosures. **Heat Mass Transfer**, 1995, 30 (3): 175-182

(3) Determining the efficiency of slotted(开缝) fin

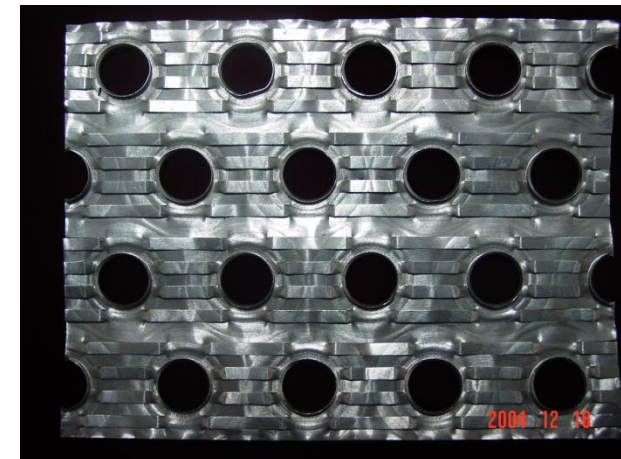
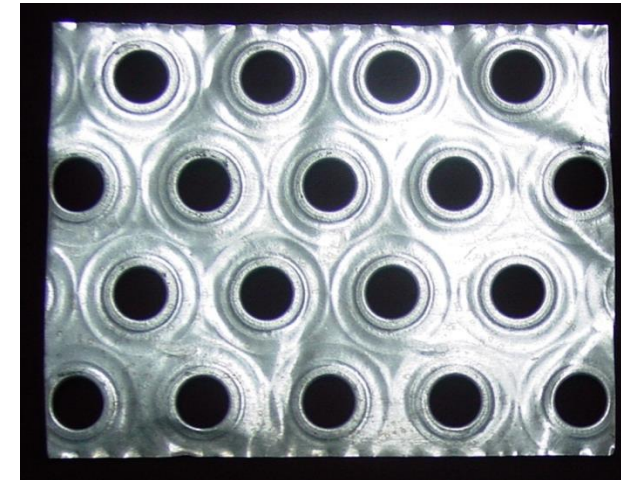
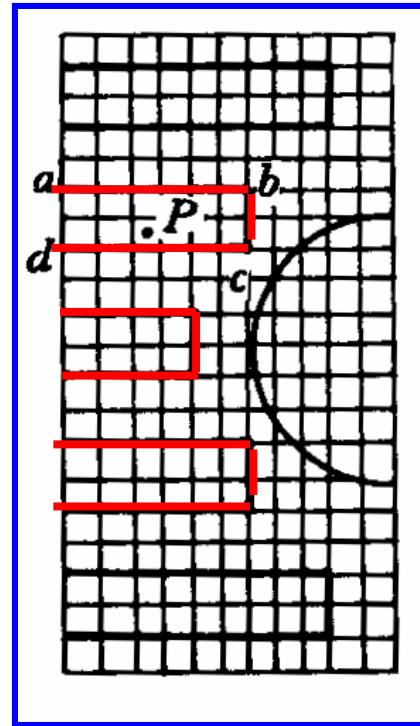
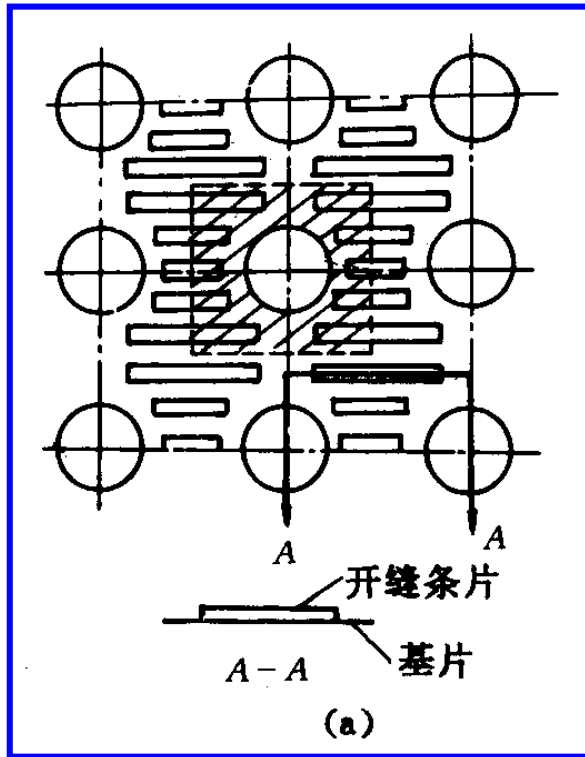

Tao WQ, Lue SS .Numerical method for calculation of slotted fin efficiency in dry condition. **Numerical Heat Transfer, Part A, 1994, 26 (3): 351-362**

(4) Simulating heat transfer and fluid flow in a welding pool (焊池)

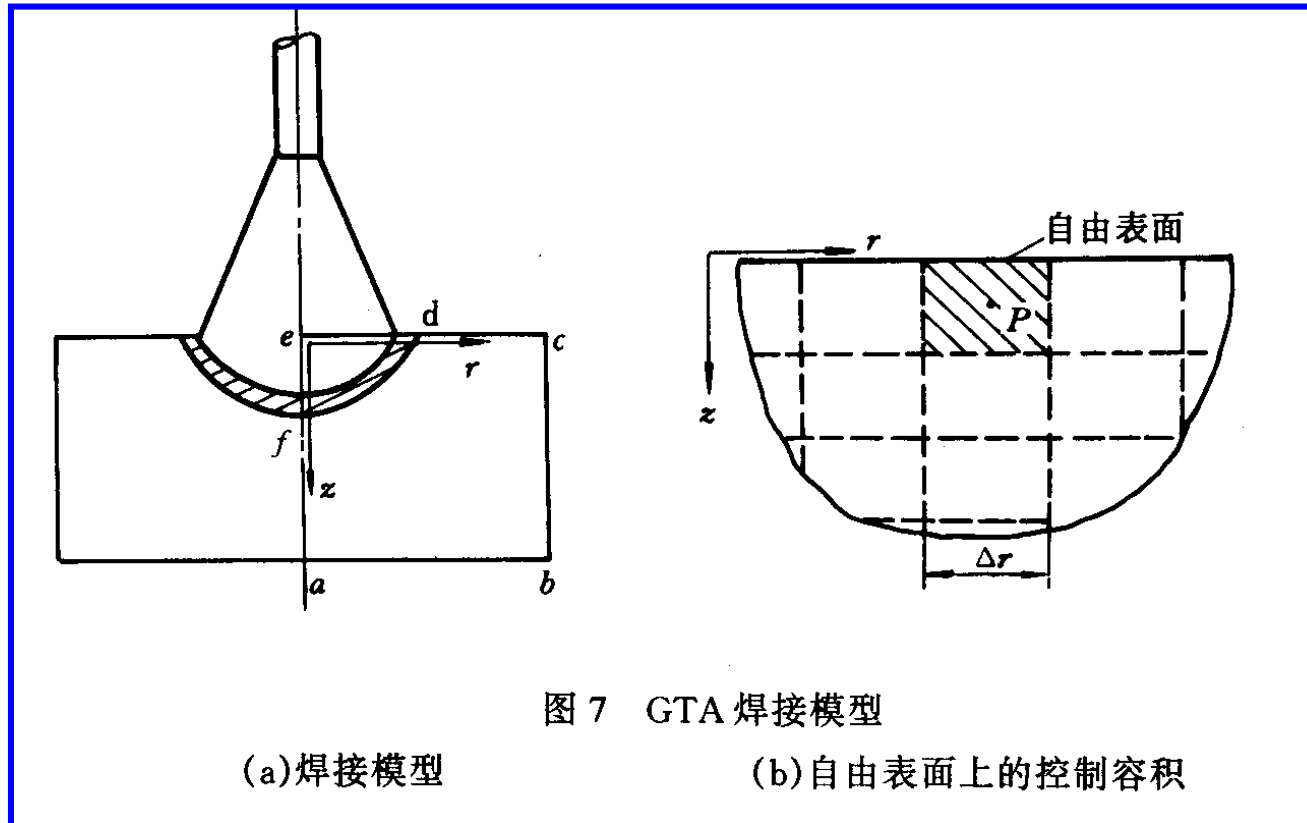

Lei Y P, Shi Y W. Numerical treatment of the boundary conditions and source term of a spot welding process with combining buoyancy – Marangoni flow. **Numerical Heat Transfer, Part b, 1994, 26 : 455-471**

本组网页地址: <http://nht.xjtu.edu.cn> 欢迎访问!
Teaching PPT will be loaded on ou website



同舟共济
渡彼岸!

People in the
same boat help
each other to
cross to the other
bank, where....