

# Numerical Heat Transfer (数值传热学)

## Chapter 9 Application Examples of the General Code for 2D Elliptical FF & HT Problems



**Instructor Tao, Wen-Quan**

Key Laboratory of Thermo-Fluid Science & Engineering  
Int. Joint Research Laboratory of Thermal Science & Engineering  
Xi'an Jiaotong University  
Innovative Harbor of West China, Xian

2019-Nov-11

9.1 2D steady heat conduction without source term in Cartesian coordinate

9.2 Steady heat conduction in a hollow cylinder

9.3 Fully-developed heat transfer in a square duct

9.4 Fully developed heat transfer in annular space with straight fin at inner wall

---

9.5 Fluid flow and heat transfer in a 2-D sudden expansion

9.6 Complicated fully developed fluid flow and heat transfer in square duct

9.7 Impinging flow on a rotating disc

9.8 Turbulent flow and heat transfer in duct with a central jet

## 9-1 2D steady heat conduction without source term in Cartesian coordinate – Knowing USER structure

### 9-1-1 Physical problem and its math formulation

**Known:** Steady heat conduction of constant properties without source term shown in Fig. 1 has following temperature distribution on four boundaries:

$$T = x + y + xy$$

**Find:** Temperature distribution within the region.

**Solution: GGE**  $\frac{\partial(\rho^* \Phi)}{\partial t} + \text{div}(\rho^* \vec{u} \Phi) = \text{div}(\Gamma_\Phi \text{grad} \Phi) + S_\Phi^*$   
 Laplace equation:  $\nabla^2 \phi = \text{div}(\text{grad} \phi) = 0$

Compared with the standard form, it is a diffusion problem with GAMA and source term as follows:

$$\Gamma_\phi = \lambda = 1, S_\phi^* = 0$$

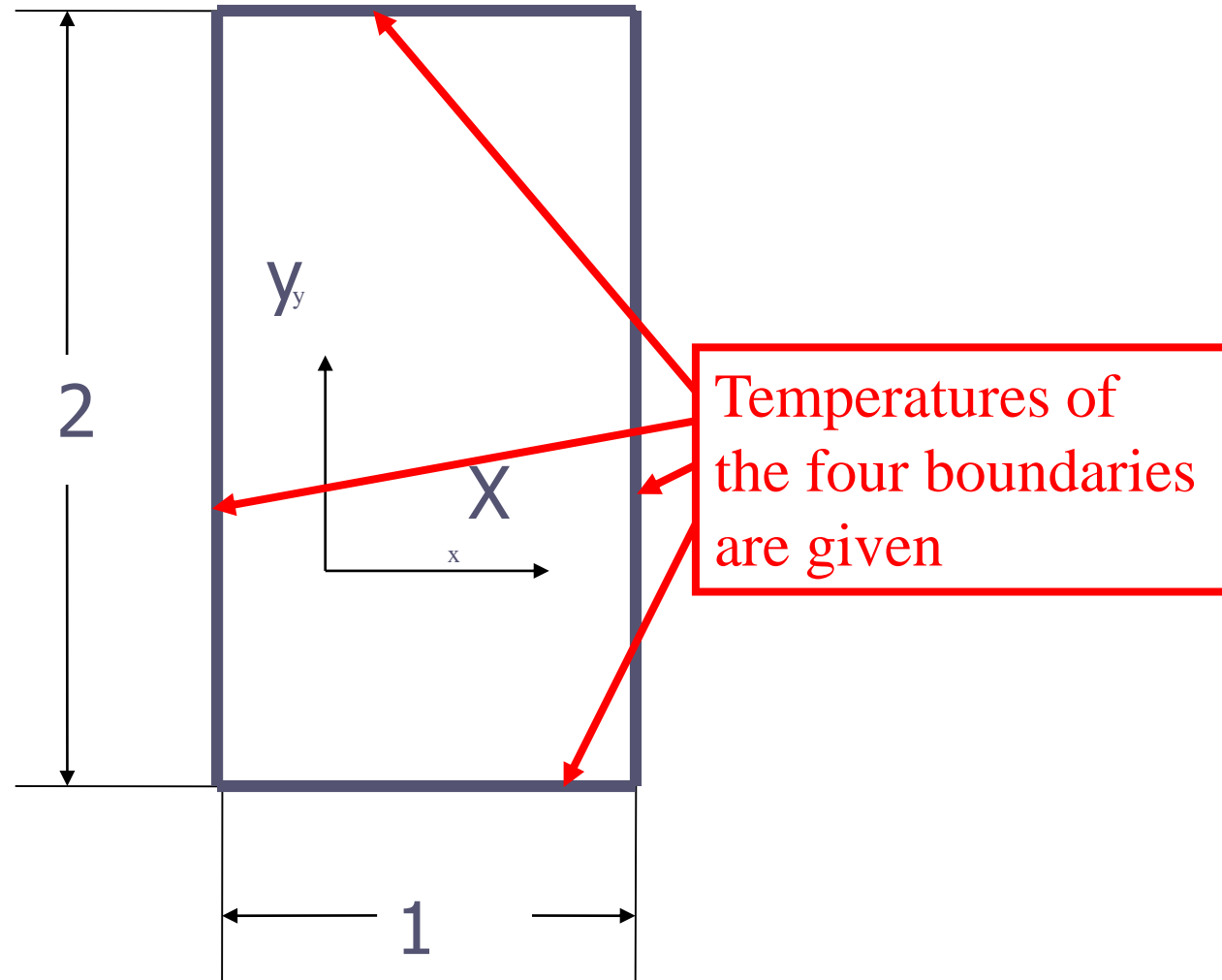

Fig.1 Computational domain

# 9-1-2 Program reading

```

CCCCCCCCCCCCCCCCCCCCCCCCCCCCCCCCCCCCCCCCCCCCCCCCCCCCCCCC
MODULE USER_L
C*****
INTEGER*4 I,J
C*****
END MODULE
CCCCCCCCCCCCCCCCCCCCCCCCCCCCCCCCCCCCCCCCCCCCCCCCCCCCCCCC
SUBROUTINE USER
C*****
USE START_L
USE USER_L
IMPLICIT NONE
C*****
*****
C-----PROBLEM ONE-----
C
C          Example of USER structure
C*****
PARAMETER(NI=100,NJ=200,NIJ=NI,NFMAX=10,NFX4=NFMAX+4)
*****
CHARACTER*8 TITLE(NFX4)
LOGICAL LSOLVE(NFX4),LPRINT(NFX4),LBLK(NFX4),LSTOP
REAL*8,DIMENSION(NI,NJ,NFX4)::F ! One 3D function
*****
ENTRY GRID
LAST=10
LSOLVE(4)=.TRUE.
LPRINT(4)=.TRUE.

```

**PARAMETER(NI=100,NJ=200,NIJ=NI,NFMAX=10,NFX4=NFMAX+4)**  
 \*\*\*\*\*  
**CHARACTER\*8 TITLE(NFX4)**  
**LOGICAL LSOLVE(NFX4),LPRINT(NFX4),LBLK(NFX4),LSTOP**  
**REAL\*8,DIMENSION(NI,NJ,NFX4)::F ! One 3D function**

! Title for output temperature field.

```
XL=1.  
YL=2.           ! MODE=1 is a default  
L1=7  
M1=7  
CALL UGRID  
RETURN  
  
ENTRY START  
DO 100 J=1,M1  
DO 101 I=1,L1   !For inner region taking zero value.  
T(I,J)=0.  
IF(I= =1.OR.I= = L1) T(I,J)=(X(I)+Y(J)+X(I)*Y(J))   !Unchanged B.C.  
IF(J= =1.OR.J= = M1) T(I,J)=(X(I)+Y(J)+X(I)*Y(J))   are given here  
101 ENDDO  
100 ENDDO  
RETURN  
  
*  
ENTRY DENSE     ! Empty, but keep it  
RETURN  
  
*  
ENTRY BOUND     ! Empty, B.C. has been set up in START  
RETURN
```

```
ENTRY OUTPUT                                ! The head only needs to be out put once
IF(ITER == 0) THEN
PRINT 401                                     ! Output to screen
WRITE(8,401)                                  ! Output through file
401 FORMAT(1X,' ITER',13X,'T(4,4)',14X,'T(5,3)')
ELSE
PRINT 403, ITER, T(4,4), T(5,3)              ! Print out two temps. in each
WRITE(8,403) ITER,T(4,4),T(5,3)              iteration for observation
403 FORMAT(1X,I5,2F20.6)
ENDIF
IF(ITER == LAST) CALL PRINT                  ! Out put 2D field after
RETURN                                       getting converged solution.

*
ENTRY GAMSOR
IF(ITER == 0) THEN                          ! For constant property problem call once only
DO 500 J=1,M1
DO 501 I=1,L1
GAM(I,J)=1.                                ! The zero initial values of Sc, Sp have been set in
501 ENDDO                                    "RESET". Only GAMA is set up here.
500 ENDDO
ELSE
ENDIF
RETURN
END
```

# 9-1-3 Analysis of results

## COMPUTATION IN CARTESIAN COORDINATES

\*\*\*\*\*

ITER	T(4,4)	T(5,3)
0	0.000000	0.000000
1	1.999978	1.720364
2	2.000000	1.720001
3	2.000000	1.720000
4	2.000000	1.720000
5	2.000000	1.720000
6	2.000000	1.720000
7	2.000000	1.720000
8	2.000000	1.720000
9	2.000000	1.720000
10	2.000000	1.720000

! Head, resulted from Statement 401 in OUTPUT ENTRY

! Resulted from Statement PRINT 403, WRITE (8,403) in OUTPUT ENTRY

403 FORMAT(1X,I5,2F20.6)

2F20.6

2F-two floating-point number

20.6-Every data take 20 places; after decimal (小数点) there are 6 digits



```

***** .TEMP. *****

I=   1           2           3           4           5           6           7
J
7  2.00E+00 2.30E+00 2.90E+00 3.50E+00 4.10E+00 4.70E+00 5.00E+00
6  1.80E+00 2.08E+00 2.64E+00 3.20E+00 3.76E+00 4.32E+00 4.60E+00
5  1.40E+00 1.64E+00 2.12E+00 2.60E+00 3.08E+00 3.56E+00 3.80E+00
4  1.00E+00 1.20E+00 1.60E+00 2.00E+00 2.40E+00 2.80E+00 3.00E+00
3  6.00E-01 7.60E-01 1.08E+00 1.40E+00 1.72E+00 2.04E+00 2.20E+00
2  2.00E-01 3.20E-01 5.60E-01 8.00E-01 1.04E+00 1.28E+00 1.40E+00
1  0.00E+00 1.00E-01 3.00E-01 5.00E-01 7.00E-01 9.00E-01 1.00E+00
    
```



## COMPUTATION IN CARTESIAN COORDINATES

\*\*\*\*\*

The above printed title for coordinate is the results of implementing following statements;

(1) In the GRID of USER we accept the default value of MODE=1;

(2) Format statement at the beginning of SETUP:

```
1 FORMAT(//15X,'COMPUTATION IN CARTESIAN COORDINATES')
```

(3) Write statement at the end of SETUP1:

```
IF(MODE= = 1) WRITE(8,1)
```

```
***** .TEMP. *****
```

The above printed title for the temperature field is the results of implementing following statements;

(1) In the GRID of UER: **TITLE(4)=' .TEMP. '**

(2) In the SUPPLY of main program:

```
10 FORMAT(1X,26(1H*),3X,A10,3X,26(1H*))
```

(3) In the ENTRY PRINT: **WRITE(8,10) TITLE(NF)**

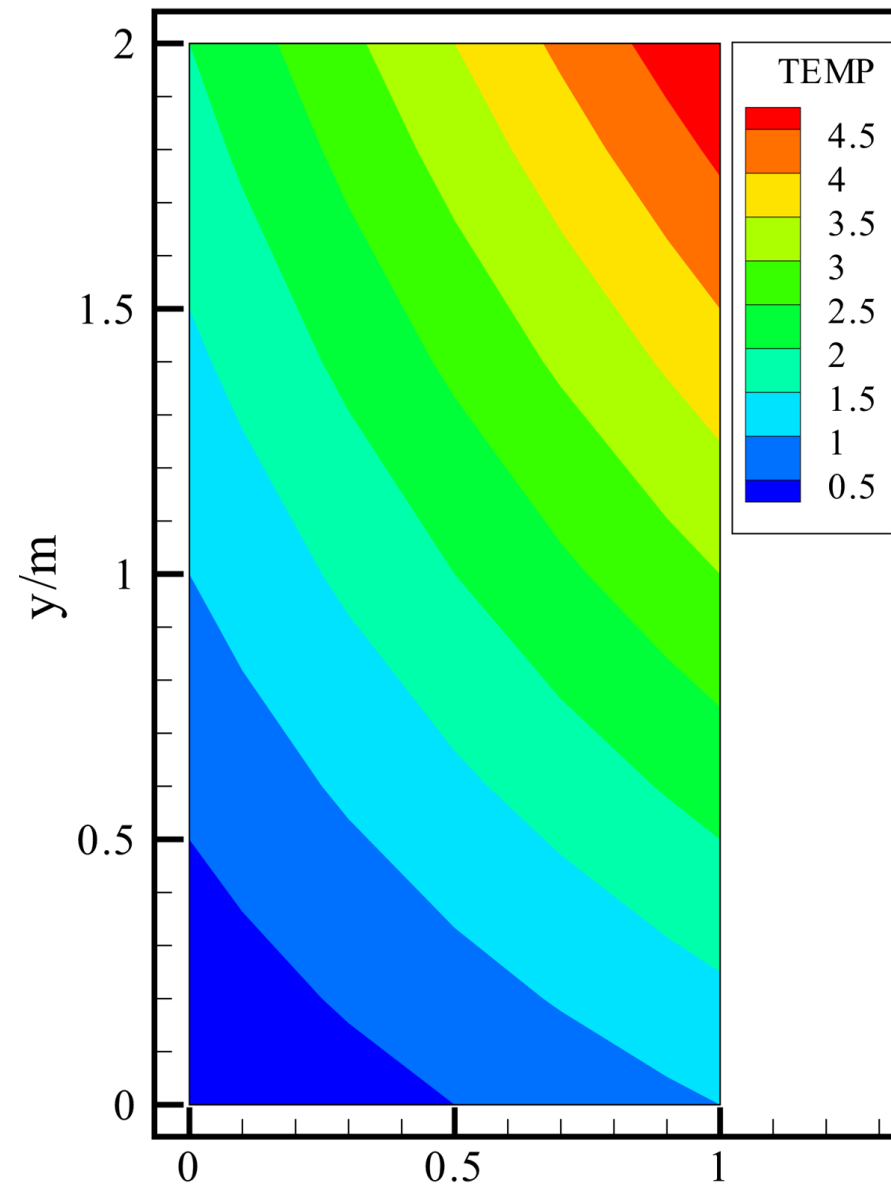

Fig. 2 Isotherms from TECPLOT

## 9-2 Steady heat conduction in a hollow cylinder ---ASTM for 2<sup>nd</sup> and 3<sup>rd</sup> boundary conditions

### 9-2-1 Physical problem and its math formulation

**Known:** Steady heat conduction in a hollow cylinder with variable property and source term shown in Fig. 1 has following boundary conditions:

Left boundary---given temperature:

$$T=100(1+y)$$

Right boundary---convective heat transfer:

Heat transfer coefficient  $H=5$ ;

Fluid temperature  $T_f=100$ .

Top boundary---adiabatic;

Bottom boundary---given heat flux:  $Q=50$

Entire region---non-linear source term:

$$S=100-0.5T$$

Thermal conductivity---for most region,  $\lambda = 1$

in a local region  $\lambda = 0.2(1+T / 100)$

**Remarks:** In all examples, physical quantities are only given by their numerical values without units. It is assumed that all units are **homogeneous**(单位和谐) .

**Find:** temperature distribution in the domain.

**Solution:**

$$\text{div}(\Gamma_{\phi} \text{grad} \phi) + S_{\phi}^* = 0$$

It is a conduction problem with given GAMA and source term:  $\Gamma_{\phi} S_{\phi}^*$ .

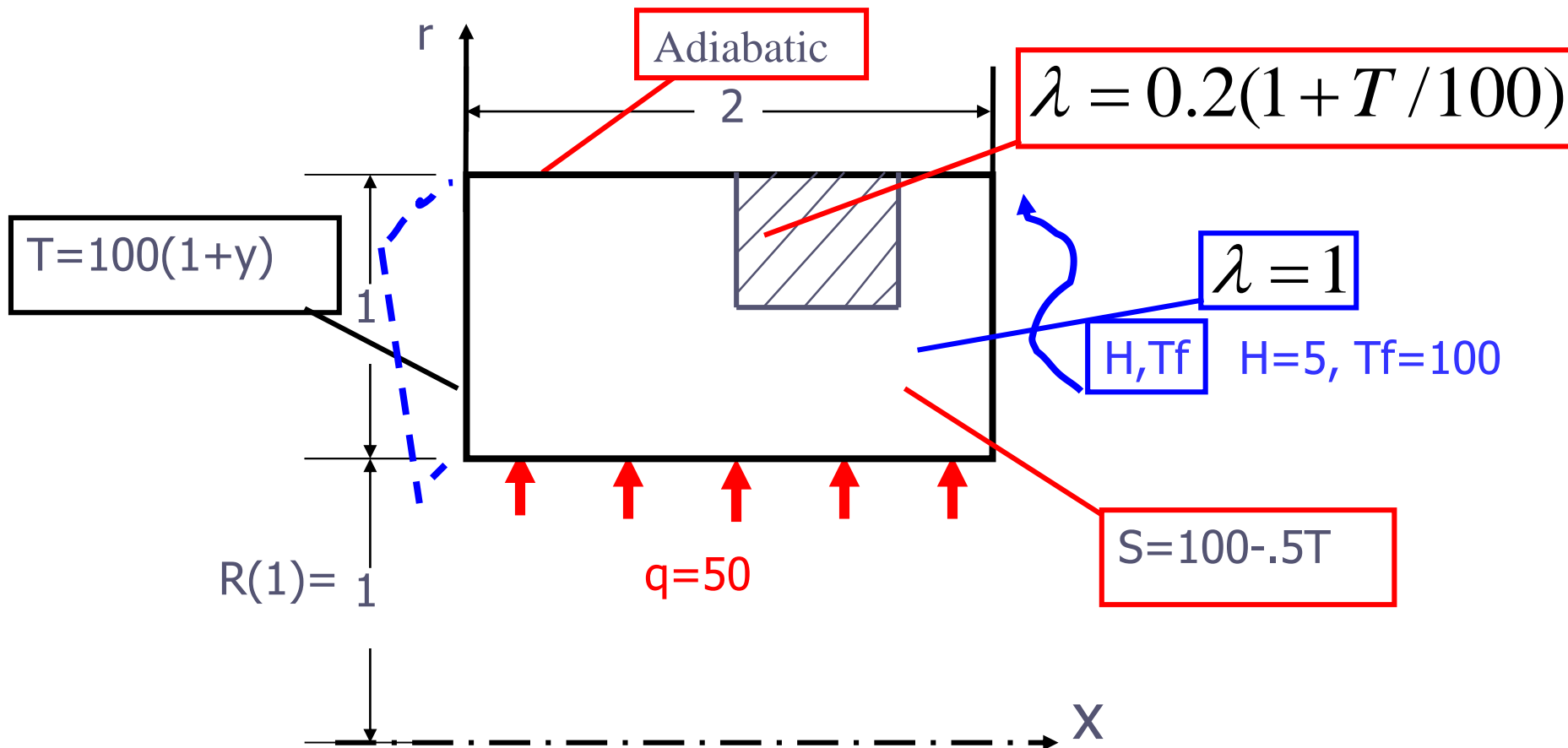

Fig.1 Computational domain

## 9-2-2 Program reading

```
CCCCCCCCCCCCCCCCCCCCCCCCCCCCCCCCCCCCCCCCCCCCCCCCCCCCCCCC
MODULE USER_L
C*****
INTEGER*4 METHOD, I, J
REAL*8 HTC, TF, GAM1, GY, RES,ARES
C*****
END MODULE
CCCCCCCCCCCCCCCCCCCCCCCCCCCCCCCCCCCCCCCCCCCCCCCCCCCCCCCC
SUBROUTINE USER
C*****
USE START_L
USE USER_L
IMPLICIT NONE
C*****
*****
C-----PROBLEM TWO----- C Two
-dimensional steady-state heat conduction in a hollow cylinder
C----Implementation of ASTM and comparison with updating method-----
C-----
C*****
```

## ENTRY GRID

TITLE(4)= ' .TEMP. ' ! Title for temperature field print out

LSOLVE(4)=.TRUE.

LAST=100

TITLE(13)= ' .COND. ' ! Title for variable conductivity print out

LPRINT(4)=.TRUE. ! Regarding GAMA as the 13<sup>th</sup> variable,

LPRINT(13)=.TRUE. for print out variable conductivity

MODE=2

XL=2.

YL=1.

R(1)=1.

L1=7

M1=7

CALL UGRID

RETURN

Specify lengths and node numbers of domain

**EQUIVALENCE(F(1,1,1),U(1,1)),(F(1,1,2),V(1,1)),(F(1,1,3),PC(1,1))**  
**1, (F(1,1,4),T(1,1))**  
**EQUIVALENCE(F(1,1,11),P(1,1)),(F(1,1,12),RHO(1,1)),(F(1,1,13)**  
**1,GAM(1,1),(F(1,1,14),CP(1,1))**



## ENTRY START

```
METHOD=1           ! Boundary temperature updated method;  
DO 100 J=1,M1       ! While METHOD= 2 is ASTM method  
DO 101 I=1,L1  
T(I,J)=200.  
IF(I == 1) T(I,J)=100.*(1.+Y(J))  ! Specify left boundary  
101 ENDDO           temperature  
100 ENDDO  
HTC=5.                
Q=50.  
TF=100.  
GAM1=1.            ! Set up conductivity value for main body  
RETURN
```

\*

## ENTRY DENSE

```
RETURN           ! Empty, but keep it
```

```

ENTRY BOUND
DO 300 I=2,L2
T(I,M1)=T(I,M2)
T(I,1)=T(I,2)+Q*YDIF(2)/GAM1
300 ENDDO
GY=GAM1/XDIF(L1)
DO 301 J=2,M2
T(L1,J)=(HTC*TF+GY*T(L2,J))/(HTC+GY)
301 ENDO
RETURN
    
```

! For METHOD 1, updated temperature  
 ! For METHOD 2, getting boundary temp. after coveredged  
 ! Temporary variable for later application  
 ! East boundary , updated temperature

$$q = \lambda \frac{T(i,1) - T(i,2)}{YDIF(2)}$$

Heat transferring into the region is taken as positive!

$$T(i,1) = T(i,2) + q \frac{YDIF(2)}{\lambda}$$

$$h(T_f - T_{L1}) = \frac{\lambda}{XDIF(L1)} (T_{L1} - T_{L2}) = GY (T_{L1} - T_{L2})$$

$$hT_f + GYT_{L2} = T_{L1} (h + GY)$$

$$T_{L1} = (hT_f + GYT_{L2}) / (h + GY)$$

```
ENTRY OUTPUT
IF(ITER= =0) THEN
PRINT 403, METHOD
WRITE(8,403) METHOD
403 FORMAT(1X,' METHOD =',I 1)
PRINT 401
WRITE(8,401)
401 FORMAT(1X,' ITER',11X,'T(4,5)',14X,'T(5,3)')
ENDIF
IF (ITER>0) PRINT 402,ITER, T(4,5), T(5.3)
WRITE(8,402) ITER,T(4,5),T(5,3)
402 FORMAT(1X,I6,2F20.6)
IF(ITER= =LAST) CALL PRINT
RETURN
```

METHOD is an indicator for boundary condition treatment for 2<sup>nd</sup> and 3<sup>rd</sup> kinds

“I1” shows that the value of METHOD is expressed by an integer with one digit

! Integer has at most six digits; 2 floating-point data with 6 digits after decimal and total length of 20 places.

### ENTRY GAMSOR

```
DO 500 J=1,M1  
DO 501 I=1,L1  
GAM(I,J)=GAM1  
501 ENDDO  
500 ENDDO  
DO 503 J=4,7  
DO 504 I=4,5  
GAM(I,J)=0.2*(1.+T(I,J)/100.)  
504 ENDDO  
503 ENDDO  
DO 510 J=2,M2  
DO 511 I=2,L2  
CON(I,J)=100.  
AP(I,J)=-.5  
511 ENDDO  
510 ENDDO
```

! Specify GAMA for whole domain  
GAMA =Lamda

! Specify variable conductivity

! Specify source term S=100-.5T

IF(METHOD= =1) RETURN ! Following is for ASTM

DO 520 I=2,L2

GAM(I,M1)=0.

GAM(I,1)=0.

CON(I,2)=CON(I,2)+Q\*R(1)/ARX(2)

520 ENDDO

RES=1./HTC+1./GV ! Accumulative

ARES=1./(RES\*XCV(L2))

DO 521 J=2,M2

GAM(L1,J)=0.

CON(L2,J)=CON(L2,J)+ARES\*TF

AP(L2,J)=AP(L2,J)-ARES

521 ENDDO

RETURN

END

South B:  $S_{c,ad} = \frac{qA}{\Delta V} = \frac{q \cdot XCV(i) \cdot R(1)}{ARX(2) \cdot XCV(i)} = \frac{q \cdot R(1)}{ARX(2)}$

Adiabatic

$$\frac{A}{\Delta V} = \frac{ARX(j)}{ARX(j) \cdot XCV(i)}$$

$$= \frac{1}{XCV(i)}$$

$$S_{c,ad} = \frac{A}{\Delta V} \frac{T_f}{\delta x / \Gamma + 1/h} =$$

$$= \frac{1}{XCV(i)} \frac{1}{\delta x / \Gamma + 1/h} \frac{T_f}{ARES}$$

! Adiabatic for ASTM

$$S_{P,ad} = - \frac{1}{XCV(i)} \frac{1}{\delta x / \Gamma + 1/h}$$

! Accumulative

Right wall

# 9-2-3 Results analysis

## COMPUTATION FOR AXISYMMETRICAL SITUATION

\*\*\*\*\*

METHOD =1

ITER	T(4,5)	T(5,3)
0	200.000000	200.000000
1	196.503891	193.806549
2	194.450150	190.325912
3	192.184113	187.114395
4	189.861618	184.072250
5	187.567535	181.222870
6	185.361771	178.597488
7	183.282364	176.208923
8	181.350449	174.055115
9	179.575180	172.125107
10	177.957458	170.403229

Initial field



11	176.492798	168.871887
12	175.173325	167.513016
13	173.989273	166.309189
14	172.930008	165.243973
15	171.984665	164.302246
16	171.142624	163.470215
17	170.393753	162.735428
18	169.728561	162.086731
19	169.138290	161.514206
20	168.614944	161.008957
21	168.151245	160.563156
22	167.740601	160.169846
23	167.377090	159.822830
24	167.055481	159.516693
25	166.770981	159.246658

26	166.519409	159.008408
27	166.296982	158.798203
28	166.100388	158.612778
29	165.926620	158.449173
30	165.773102	158.304855
31	165.637451	158.177505
32	165.517609	158.065186
33	165.411758	157.966049
34	165.318222	157.878601
35	165.235626	157.801422
36	165.162720	157.733337
37	165.098282	157.673233
38	165.041412	157.620209
39	164.991196	157.573425
40	164.946838	157.532135
41	164.907684	157.495712
42	164.873108	157.463547



43	164.842590	157.435181
44	164.815643	157.410141
45	164.791870	157.388062
46	164.770844	157.368561
47	164.752319	157.351334
48	164.735947	157.336151
49	164.721497	157.322754
50	164.708740	157.310913
51	164.697495	157.300476
52	164.687561	157.291245
53	164.678772	157.283127
54	164.671051	157.275940
55	164.664200	157.269608
56	164.658157	157.264008
57	164.652847	157.259094
58	164.648148	157.254730
59	164.643982	157.250885
60	164.640289	157.247482

61	164.637070	157.244492
62	164.634201	157.241837
63	164.631683	157.239502
64	164.629471	157.237442
65	164.627502	157.235626
66	164.625778	157.234024
67	164.624268	157.232590
68	164.622894	157.231339
69	164.621689	157.230225
70	164.620636	157.229279
71	164.619736	157.228409
72	164.618896	157.227646
73	164.618179	157.226990
74	164.617538	157.226379
75	164.616974	157.225861
76	164.616486	157.225418
77	164.616058	157.225021
78	164.615662	157.224655
79	164.615341	157.224350
80	164.615036	157.224060

81	164.614746	157.223816
82	164.614517	157.223587
83	164.614304	157.223389
84	164.614120	157.223236
85	164.613968	157.223068
86	164.613815	157.222931
87	164.613693	157.222839
88	164.613571	157.222717
89	164.613495	157.222641
90	164.613403	157.222549
91	164.613312	157.222488
92	164.613251	157.222412
93	164.613205	157.222382
94	164.613159	157.222321
95	164.613113	157.222275
96	164.613037	157.222229
97	164.613007	157.222214
98	164.612976	157.222168
99	164.612946	157.222153
100	164.612930	157.222137

The 1st three digits  
after decimal  
unchanged during 5  
iterations!

```
*****  
***** TEMP *****  
  
I =      1      2      3      4      5      6      7  
J  
7  2.00E+02 1.75E+02 1.70E+02 1.64E+02 1.48E+02 1.25E+02 2.00E+02  
6  1.90E+02 1.75E+02 1.70E+02 1.64E+02 1.48E+02 1.25E+02 1.12E+02  
5  1.70E+02 1.69E+02 1.69E+02 1.65E+02 1.49E+02 1.26E+02 1.13E+02  
4  1.50E+02 1.60E+02 1.68E+02 1.66E+02 1.52E+02 1.28E+02 1.14E+02  
3  1.30E+02 1.52E+02 1.68E+02 1.70E+02 1.57E+02 1.33E+02 1.16E+02  
2  1.10E+02 1.49E+02 1.72E+02 1.75E+02 1.63E+02 1.39E+02 1.19E+02  
1  1.00E+02 1.54E+02 1.77E+02 1.80E+02 1.68E+02 1.44E+02 2.00E+02
```

```
*****  
COND  
*****  
  
I =      1      2      3      4      5      6      7  
J  
7  1.00E+00 1.00E+00 1.00E+00 5.28E-01 4.95E-01 1.00E+00 1.00E+00  
6  1.00E+00 1.00E+00 1.00E+00 5.28E-01 4.95E-01 1.00E+00 1.00E+00  
5  1.00E+00 1.00E+00 1.00E+00 5.29E-01 4.98E-01 1.00E+00 1.00E+00  
4  1.00E+00 1.00E+00 1.00E+00 5.33E-01 5.05E-01 1.00E+00 1.00E+00  
3  1.00E+00 1.00E+00 1.00E+00 1.00E+00 1.00E+00 1.00E+00 1.00E+00  
2  1.00E+00 1.00E+00 1.00E+00 1.00E+00 1.00E+00 1.00E+00 1.00E+00  
1  1.00E+00 1.00E+00 1.00E+00 1.00E+00 1.00E+00 1.00E+00 1.00E+00
```

## COMPUTATION FOR AXISYMMETRICAL SITUATION

\*\*\*\*\*

### METHOD =2

ITER	T(4,5)	T(5,3)
0	200.000000	200.000000
1	163.633240	156.107574
2	164.603409	157.204285
3	164.612839	157.222092
4	164.612747	157.221954
5	164.612747	157.221954
6	164.612747	157.221954
7	164.612747	157.221970
8	164.612747	157.221954
9	164.612747	157.221970
10	164.612747	157.221954
11	164.612747	157.221970
12	164.612747	157.221954

In order to keep the  
 1<sup>st</sup> three digits after  
 decimal unchanged  
 during 5 iterations,  
 Method 1 needs 90  
 iterations, while Method  
 2 only needs 8 iterations!  
 Speed of convergence of  
 Method 2 is 10 times of  
 Method 1!

13	164.612747	157.221970
14	164.612747	157.221954
15	164.612747	157.221970
16	164.612747	157.221954
17	164.612747	157.221970
18	164.612747	157.221954
19	164.612747	157.221970
20	164.612747	157.221954
21	164.612747	157.221970
22	164.612747	157.221954
23	164.612747	157.221970
24	164.612747	157.221954
25	164.612747	157.221970
26	164.612747	157.221954
27	164.612747	157.221970
28	164.612747	157.221954
29	164.612747	157.221970
30	164.612747	157.221954

31	164.612747	157.221970
32	164.612747	157.221954
33	164.612747	157.221970
34	164.612747	157.221954
35	164.612747	157.221970
36	164.612747	157.221954
37	164.612747	157.221970
38	164.612747	157.221954
39	164.612747	157.221970
40	164.612747	157.221954
41	164.612747	157.221970
42	164.612747	157.221954
43	164.612747	157.221970
44	164.612747	157.221954
45	164.612747	157.221970
46	164.612747	157.221954
47	164.612747	157.221970
48	164.612747	157.221954



49	164.612747	157.221970
50	164.612747	157.221954
51	164.612747	157.221970
52	164.612747	157.221954
53	164.612747	157.221970
54	164.612747	157.221954
55	164.612747	157.221970
56	164.612747	157.221954
57	164.612747	157.221970
58	164.612747	157.221954
59	164.612747	157.221970
60	164.612747	157.221954
61	164.612747	157.221970
62	164.612747	157.221954
63	164.612747	157.221970
64	164.612747	157.221954
65	164.612747	157.221970
66	164.612747	157.221954

67	164.612747	157.221970
68	164.612747	157.221954
69	164.612747	157.221970
70	164.612747	157.221954
71	164.612747	157.221970
72	164.612747	157.221954
73	164.612747	157.221970
74	164.612747	157.221954
75	164.612747	157.221970
76	164.612747	157.221954
77	164.612747	157.221970
78	164.612747	157.221954
79	164.612747	157.221970
80	164.612747	157.221954
81	164.612747	157.221970
82	164.612747	157.221954
83	164.612747	157.221970
84	164.612747	157.221954

85	164.612747	157.221970
86	164.612747	157.221954
87	164.612747	157.221970
88	164.612747	157.221954
89	164.612747	157.221970
90	164.612747	157.221954
91	164.612747	157.221970
92	164.612747	157.221954
93	164.612747	157.221970
94	164.612747	157.221954
95	164.612747	157.221970
96	164.612747	157.221954
97	164.612747	157.221970
98	164.612747	157.221954
99	164.612747	157.221970
100	164.612747	157.221954

For diffusion problems further iterations after getting the converged solution will not change the results! But it is not for convective problems!

! For METHOD=2, all boundary temperatures will be used only after getting converged solution. In order to save time following IF statement may be added before DO -loop 300 :  
 IF( METHOD= 2 .AND. ITER < LAST) RETURN

In ENTRY BOUND:

$$T(I,M1)=T(I,M2)$$

$$T(I,1)=T(I,2)+Q*YDIF(2)/GAM1$$

$$T(L1,J)=(HTC*TF+GY*T(L2,J))/(HTC+GY)$$

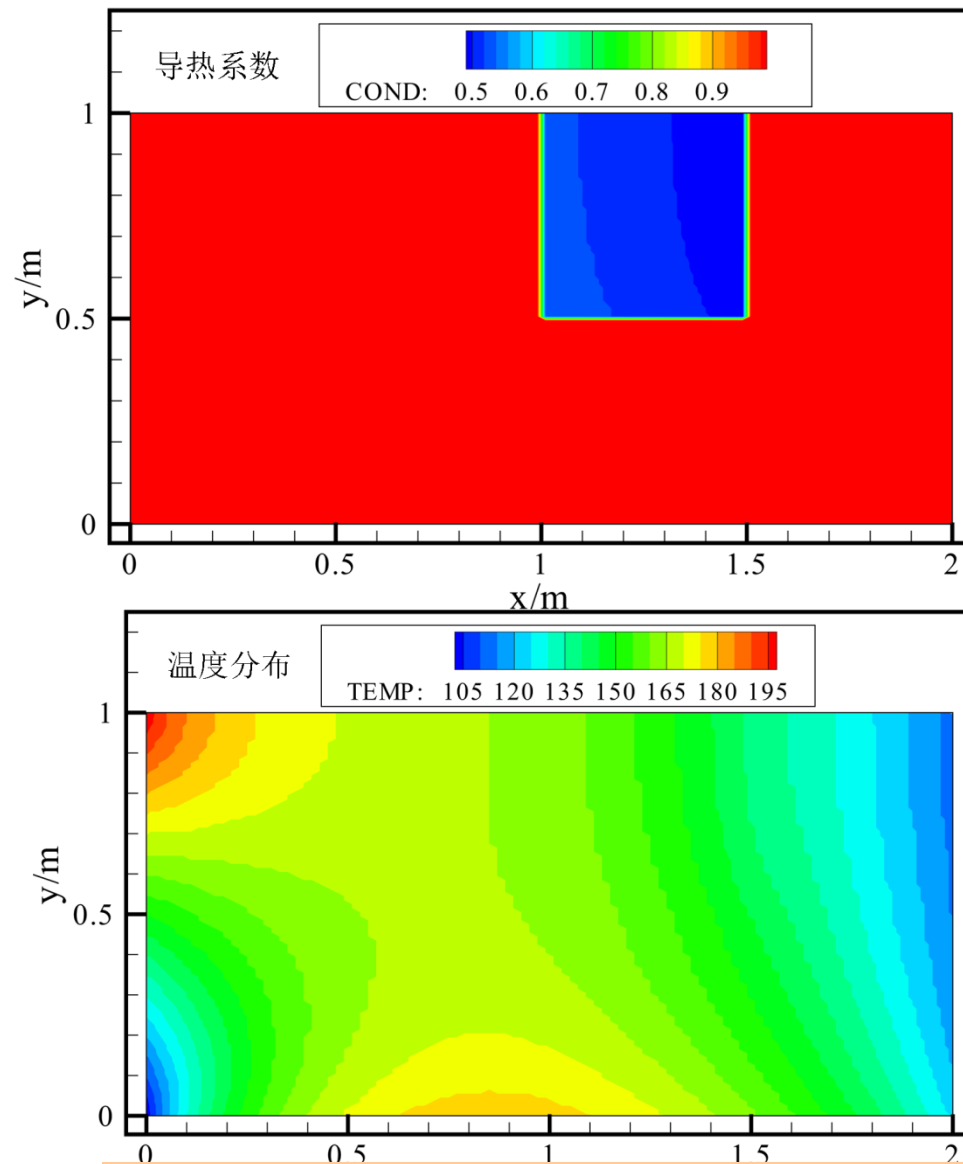

Fig.2 Computational results

# Uniform heat flux south boundary

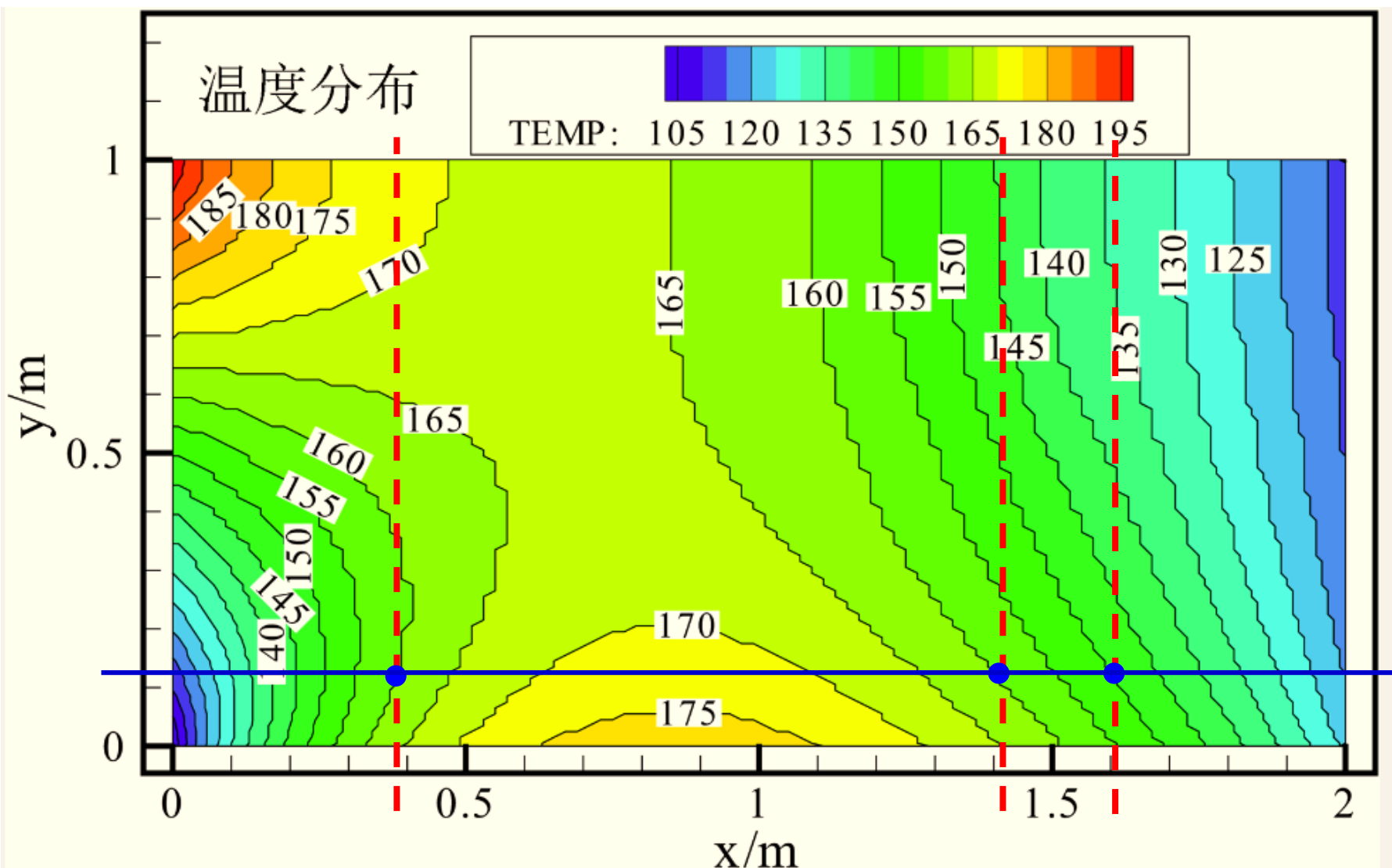

Fig.3 Isotherms

9.1 2D steady heat conduction without source term in Cartesian coordinate

9.2 Steady heat conduction in a hollow cylinder

9.3 Fully-developed heat transfer in a square duct

9.4 Fully developed heat transfer in annular space with straight fin at inner wall

---

9.5 Fluid flow and heat transfer in a 2-D sudden expansion

9.6 Complicated fully developed fluid flow and heat transfer in square duct

9.7 Impinging flow on a rotating disc

9.8 Turbulent flow and heat transfer in duct with a central jet

## 9-3 Example 3 Fully-developed heat transfer in a square duct – Numerical techniques for FDHT

### 9-3-1 Physical problem and its math formulation

**Known:** Fully developed laminar heat transfer of fluid with constant properties (Fig. 1).

**Find:** Velocity and temperature distribution in cross section and  $fRe$  and  $Nu$ .

**Solution:** For fully developed laminar flow in a straight duct, cross-sectional velocity components are zero, and the axial velocity is governed by following equation.:

$$\eta \left( \frac{\partial^2 w}{\partial x^2} + \frac{\partial^2 w}{\partial y^2} \right) - \frac{dp}{dz} = 0$$

Fig. 1 Schematic diagram of physical problem

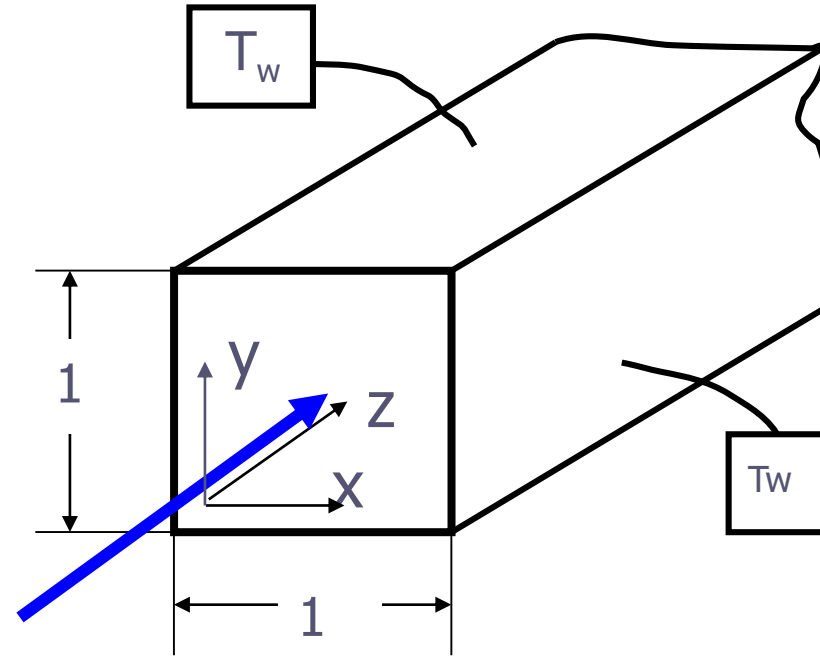

Compared with the standard form w- eq. is of **conduction type** and following results are obtained:

$$\Gamma_{\phi} = \eta \quad S_c = -dp/dz$$

Governing equation for fluid temperature:

$$\rho c_p w \frac{\partial T}{\partial z} = \frac{\partial}{\partial x} \left( \lambda \frac{\partial T}{\partial x} \right) + \frac{\partial}{\partial y} \left( \lambda \frac{\partial T}{\partial y} \right) \quad \text{Note: } u=0, v=0$$



## 9-3-2 Numerical methods

### (1) Dimensionless temperature

Defining dimensionless temperature  $\Theta = \frac{T - T_w}{T_b - T_w}$

Then:  $T = \Theta(T_b - T_w) + T_w$ ,  $\frac{\partial T}{\partial z} = \Theta \frac{dT_b}{dz}$

Energy eq. is transformed into following **conduction equation** with source term:

$$\frac{\partial}{\partial x} \left( \lambda \frac{\partial T}{\partial x} \right) + \frac{\partial}{\partial y} \left( \lambda \frac{\partial T}{\partial y} \right) - \underline{\rho c_p w \Theta} \frac{dT_b}{dz} = 0$$

Compared with the standard form:

$$\Gamma_\phi = \lambda$$

$$S_C = -\rho c_p w \Theta \frac{dT_b}{dz}$$

## (2) Numerical methods

1. This flow problem is governed by two conduction-type equations with source term;

2. The two equations are partially coupled: Velocity is in the source term of temperature; However, temperature is not included in w-equation. Thus w-eq. should be solved first;

3. For uniform wall temperature case,  $dT_w/dz$  does not equal constant and an assumed value can be used for simulation; The dimensionless temperature ( which is included in the source term of temperature ) should be updated during iteration.

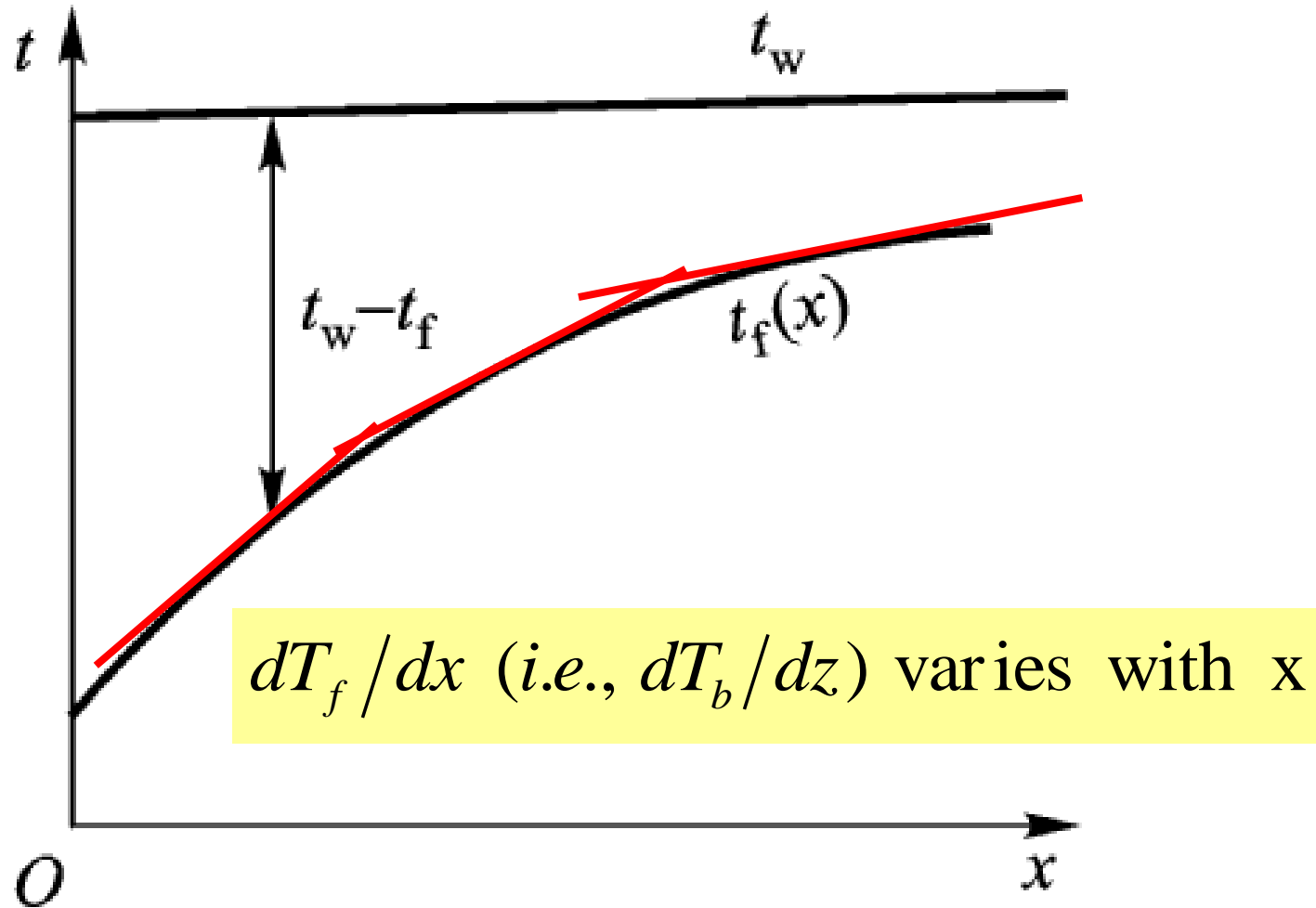

Fig. 2 Streamwise variation of fluid temperature at uniform wall temperature condition

## 9-3-3 Program reading

```
CCCCCCCCCCCCCCCCCCCCCCCCCCCCCCCCCCCCCCCCCCCCCCCCCCCCCCCC
MODULE USER_L
C*****
INTEGER*4 I,J
REAL*8 AMU, DEN, RHOCP, DPDZ, DTBDZ, ASUM, TSUM, AR,
1 WR, WBAR, TB, DH, RE, FRE, ANU, TW, QW, THETA, DTDZ
END MODULE
CCCCCCCCCCCCCCCCCCCCCCCCCCCCCCCCCCCCCCCCCCCCCCCCCCCCCCCC
SUBROUTINE USER
C*****
USE START_L
USE USER_L
IMPLICIT NONE
C*****
C-----PROBLEM THREE-----
Fully developed laminar fluid flow and heat transfer in a square duct
C-----
C*****
```

## ENTRY GRID

```

TITLE(4)=' .THETA. '      ! Title of dimensionless temperature for output
TITLE(5)=' . W/WBAR. '    ! Title of dimensionless velocity for output
LSOLVE(5)=.TRUE.
LPRINT(4)=.TRUE.          ! W solved first, temperature
LPRINT(5)=.TRUE.          is not solved temporary
LAST=22
XL=0.5                    ! Symmetric, only 1/4
YL=0.5                    domain needs to be solved
L1=7
M1=7
CALL UGRID
RETURN
    
```

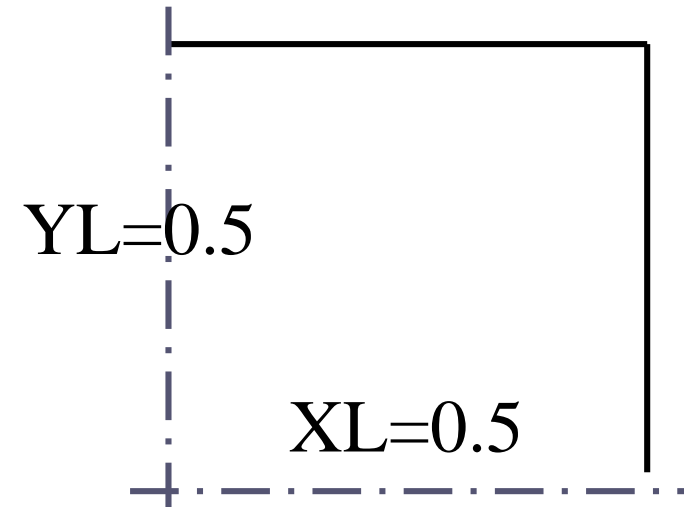

## ENTRY START

TW=0.

DO 100 J=1,M1

DO 100 I=1,L1

W(I,J)=0.

T(I,J)=1.

T(I,M1)=TW

T(L1,J)=TW

100 CONTINUE

AMU=1.

DEN=1.

COND=1.

CP=1.

RHOCP=DEN\*CP

DPDZ=-100. ! This value must be less than zero

DTBDZ=5. ! Fluid is heated. The value is arbitrary assumed

**RETURN**

! Set up initial fields

! Set up wall temp. for east and top walls

! Set up properties; Dynamic viscosity=1  
(very large), to ensure laminar flow.

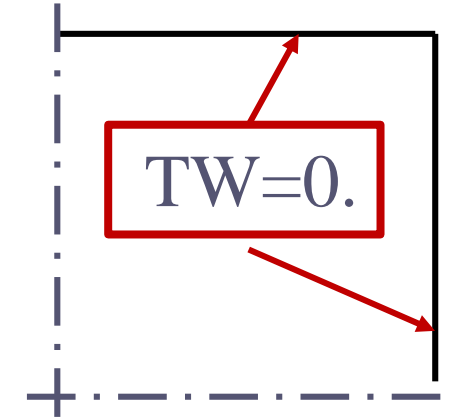

## ENTRY DENSE

RETURN

! Empty, but keep it

## ENTRY BOUND

ASUM=0.

WSUM=0.

TSUM=0.

! Initial values for summation

Element area

DO 300 J=2,M2

DO 301 I=2,L2

AR=XCV(I)\*YCV(J)

WR=W(I,J)\*AR

WSUM=WSUM+WR

ASUM=ASUM+AR

TSUM=TSUM+WR\*T(I,J)

301 ENDDO

300 ENDDO

$$\iint w(i, j) dA_{i, j}$$

$$\iint dA_i$$

$$\iint w(i, j) (T(i, j)) dA_{i, j}$$

! Average velocity  $T_b = \frac{\iint w(i, j)(T(i, j)dA_{i, j})}{\iint w(i, j)dA_{i, j}}$

WBAR=WSUM/ASUM

TB=TSUM/(WSUM+1.E-30)

DH=4.\*XL\*YL/(XL+YL)

RE=DEN\*WBAR\*DH/AMU

FRE=-2.\*DPDZ\*DH/(DEN\*WBAR\*\*2+1.E-30)\*RE

QW=DTBDZ\*RHOCP\*WSUM/(XL+YL)

ANU=QW\*DH/(COND\*(TW-TB)+1.E-30)

! To avoid overflow, a small value is added.

$f Re = -\frac{(dp/dx)D_h}{\frac{1}{2}\rho w_m^2} Re$

$q_w = \frac{dT_b}{dz} \rho c_p \sum (w_{i, j} A_{i, j}) \frac{1}{XL + YL}$

$Nu = \frac{hD_h}{\lambda} = \frac{D_h}{\lambda} \frac{q}{\Delta T}$

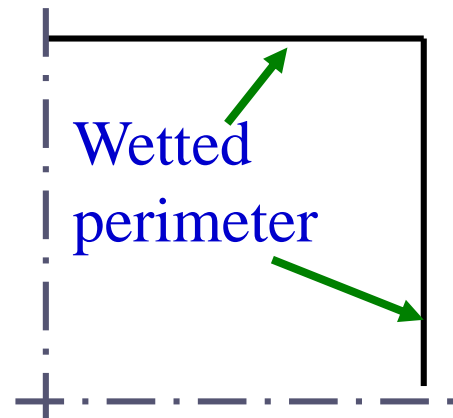



```
IF(ITER>10) LSOLVE(5)=.FALSE.
LSOLVE(4)=.TRUE.
CONTINUE
RETURN
```

! Switch of solved variable,  
very useful technique

\*

ENTRY OUTPUT

```
IF(ITER= =0) THEN
PRINT 401
WRITE(8,401)
```

In one module, if there is only one IF  
statement, it can be used without THEN and  
ENDIF.

```
401 FORMAT(1X,' ITER',12X,'F.RE',17X,'NU')
```

ELSE

```
PRINT 402, ITER,FRE,ANU
WRITE(8,402) ITER,FRE,ANU
```

```
402 FORMAT(1X,I6,1P2E20.4)
ENDIF
```

1P2E20.4, Scientific expression of data

```
IF(ITER./=LAST) RETURN
```

```
DO 410 J=1,M1
```

```
DO 411 I=1,L1
```

```
W(I,J)=W(I,J)/WBAR
```

```
T(I,J)=(T(I,J)-TW)/(TB-TW)
```

! Dimensionless to make  
the result more general

```
411 ENDDO
```

```
410 ENDDO
```

```
CALL PRINT
```

```
RETURN
```

## ENTRY GAMSOR

```

DO 500 I=1,L1
DO 500 J=1,M1
GAM(I,J)=AMU
IF(NF= = 4) GAM(I,J)=COND      ! GAMA for temperature
GAM(I,1)=0. } ! Symmetric=adiabatic for both V and T.
GAM(1,J)=0. }
500 CONTINUE
IF(NF.EQ.4) GOTO 511
DO 510 J=2,M2
DO 510 I=2,L2
CON(I,J)=-DPDZ ! Source term of W
510 CONTINUE
RETURN
511 DO 520 J=2,M2
DO 520 I=2,L2
THEAT=(T(I,J)-TW)/(TB-TW+1.E-30) ! Updating dimensionless temp.
DTDZ=THEAT*DTBDZ
520 CON(I,J)=-RHOCp*W(I,J)*DTDZ } ! Source term of temp.
RETURN
END
    
```

$$S_C = -\rho c_p w \ominus \frac{dT_b}{dz}$$

# 9-3-4 Results analysis

## COMPUTATION IN CARTESIAN COORDINATES

\*\*\*\*\*

ITER	F.RE	NU
0	0.0000E+00	0.0000E+00
1	6.5168E+01	-3.8363E+00
2	5.6545E+01	-4.4212E+00
3	5.5151E+01	-4.5330E+00
4	5.4891E+01	-4.5545E+00
5	5.4841E+01	-4.5587E+00
6	5.4831E+01	-4.5595E+00
7	5.4829E+01	-4.5596E+00
8	5.4829E+01	-4.5596E+00
9	5.4829E+01	-4.5596E+00
10	5.4829E+01	-4.5596E+00
11	5.4829E+01	4.5875E+00
12	5.4829E+01	3.3408E+00
13	5.4829E+01	3.0894E+00
14	5.4829E+01	3.0361E+00
15	5.4829E+01	3.0257E+00

Energy eq. has not been solved. The values are meaningless

1P2E20.4

Switch of solved variable

16	5.4829E+01	3.0240E+00
17	5.4829E+01	3.0238E+00
18	5.4829E+01	3.0237E+00
19	5.4829E+01	3.0237E+00
20	5.4829E+01	3.0238E+00
21	5.4829E+01	3.0238E+00
22	5.4829E+01	3.0238E+00



Four digits after decimal  
remain unchanged in  
successive 6 iterations

\*\*\*\*\*.W/WBAR.\*\*\*\*\*

I =	1	2	3	4	5	6	7
J							
7	0.00E+00	0.00E+00	0.00E+00	0.00E+00	0.00E+00	0.00E+00	0.00E+00
6	0.00E+00	4.58E-01	4.34E-01	3.83E-01	2.95E-01	1.44E-01	0.00E+00
5	0.00E+00	1.12E+00	1.06E+00	9.12E-01	6.72E-01	2.95E-01	0.00E+00
4	0.00E+00	1.58E+00	1.48E+00	1.26E+00	9.12E-01	3.83E-01	0.00E+00
3	0.00E+00	1.87E+00	1.74E+00	1.48E+00	1.06E+00	4.34E-01	0.00E+00
2	0.00E+00	2.00E+00	1.87E+00	1.58E+00	1.12E+00	4.58E-01	0.00E+00
1	0.00E+00	0.00E+00	0.00E+00	0.00E+00	0.00E+00	0.00E+00	0.00E+00

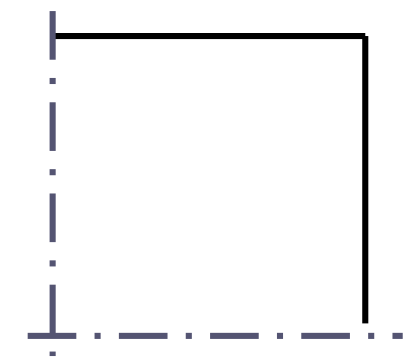

No decoration before output (未作修饰)

\*\*\*\*\* .THETA. \*\*\*\*\*

I =	1	2	3	4	5	6	7
J							
7	0.00E+00	0.00E+00	0.00E+00	0.00E+00	0.00E+00	0.00E+00	0.00E+00
6	-6.63E-01	2.41E-01	2.14E-01	1.65E-01	1.02E-01	3.41E-02	0.00E+00
5	-6.63E-01	7.38E-01	6.53E-01	5.00E-01	3.07E-01	1.02E-01	0.00E+00
4	-6.63E-01	1.22E+00	1.08E+00	8.19E-01	5.00E-01	1.65E-01	0.00E+00
3	-6.63E-01	1.61E+00	1.42E+00	1.08E+00	6.53E-01	2.14E-01	0.00E+00
2	-6.63E-01	1.84E+00	1.61E+00	1.22E+00	7.38E-01	2.41E-01	0.00E+00
1	-6.63E-01	-6.63E-01	-6.63E-01	-6.63E-01	-6.63E-01	-6.63E-01	0.00E+00

No decoration(未作修饰)

Decoration: before output, set:  
 $THETA(1, j) = THETA(2, j)$   
 $THETA(i, 1) = THETA(i, 2)$

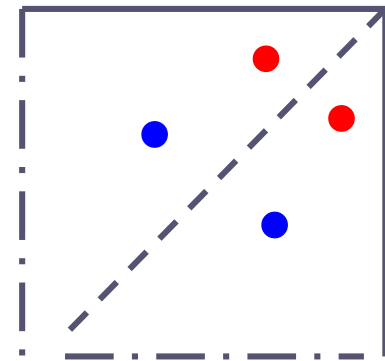

Symmetry  
about  
diagonal

No decoration

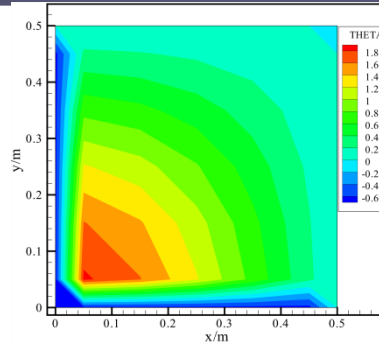

No decoration

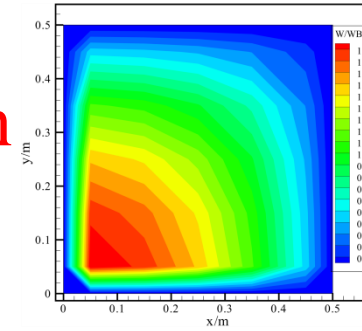

With decoration

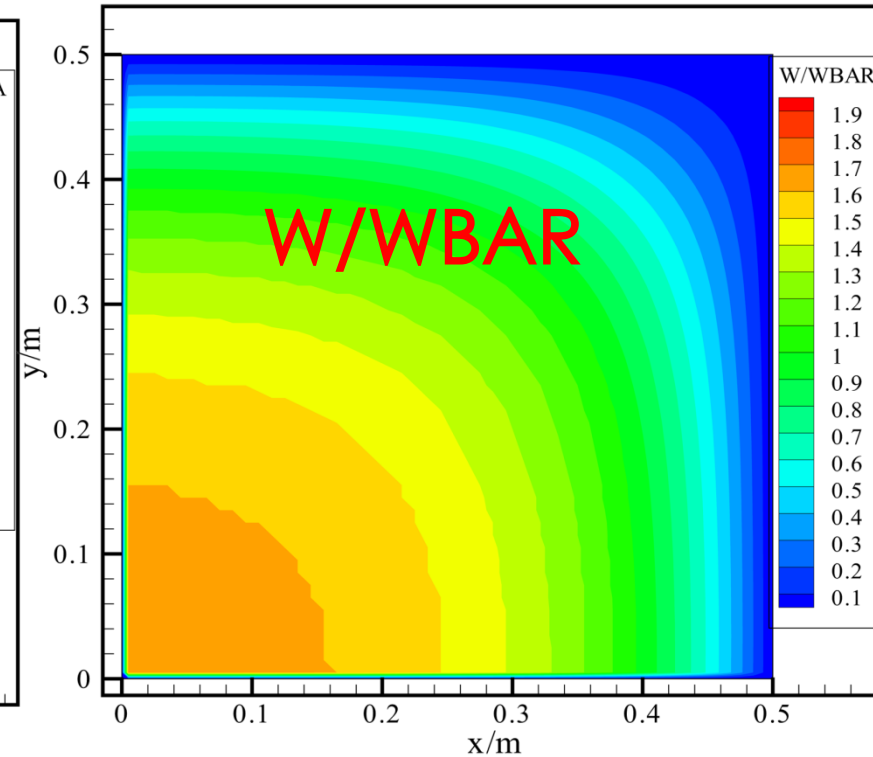
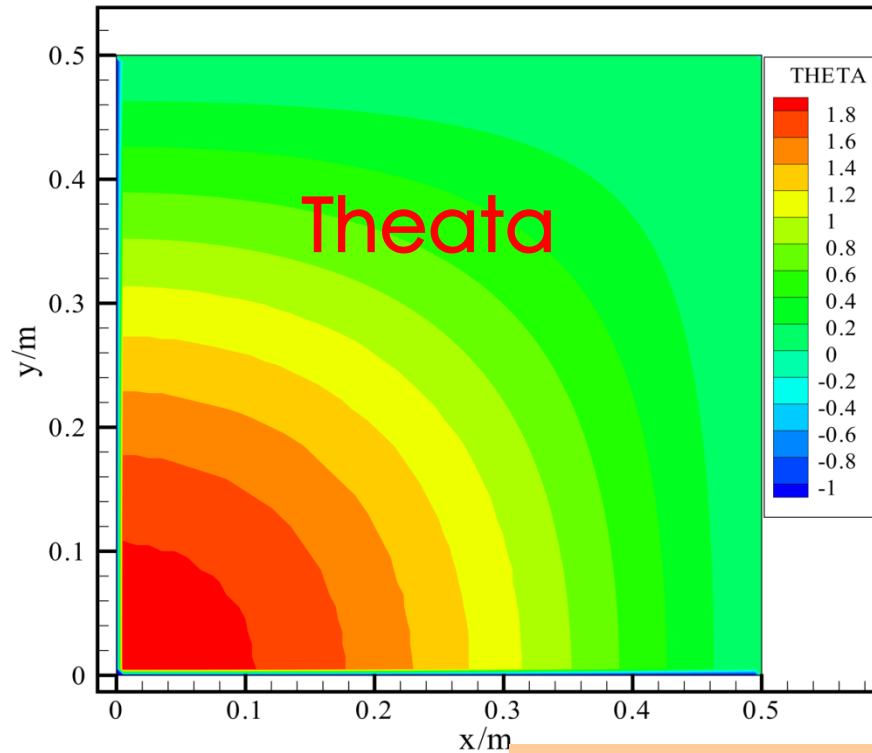

Fig. 3 Results of Problem 3

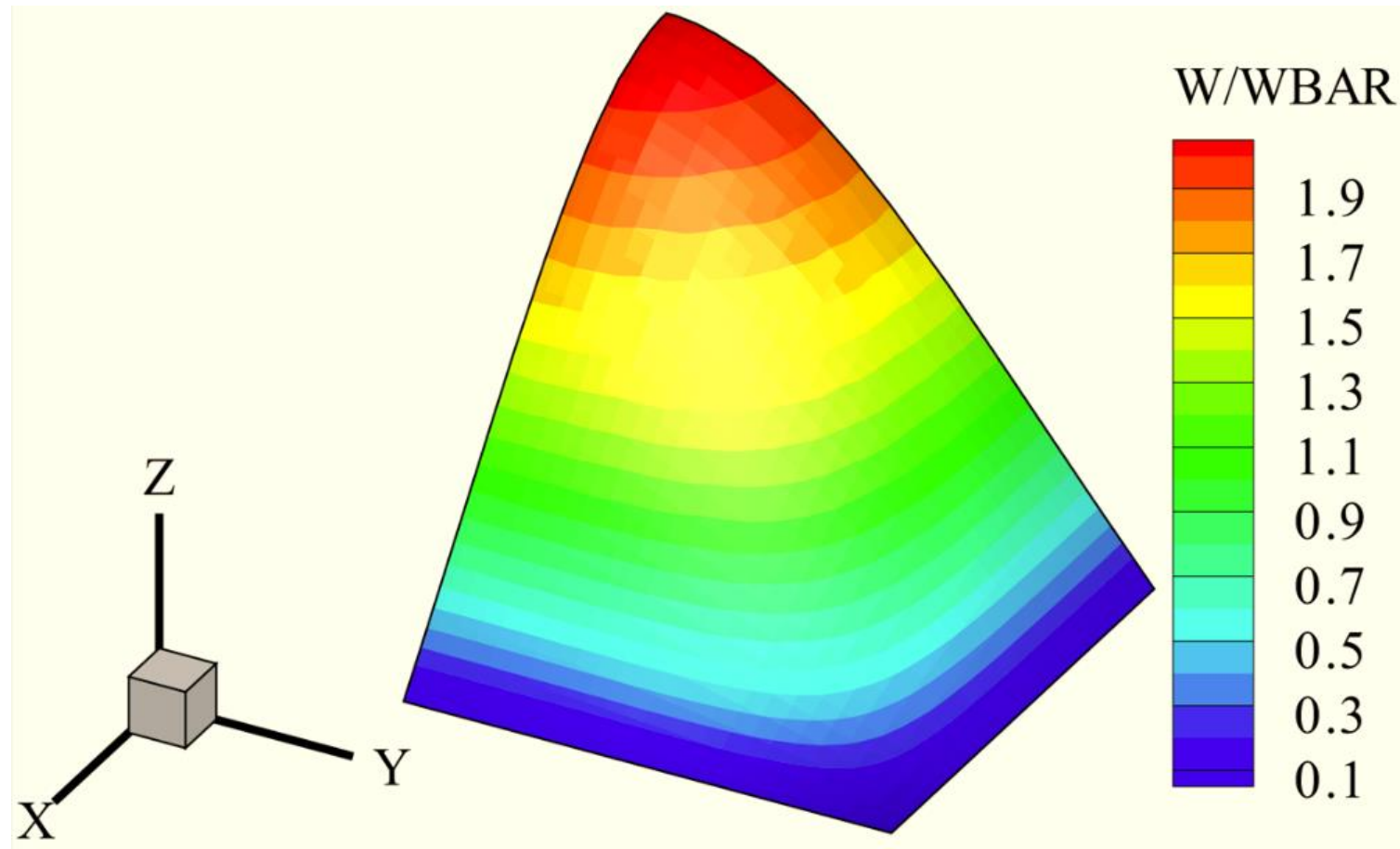

Fig. 4 Pictorial (立体) view of axial velocity distribution

## 9-4 Fully developed heat transfer in annular space with straight fin at inner wall

– Numerical methods for conjugated problems

### 9-4-1 Physical Problem and its math formulation

**Known:** Laminar heat transfer with constant properties in annular space with straight fins at inner wall (Fig. 1). Its outer wall is adiabatic, while inner wall temperature is circumferentially uniform (周向均匀壁温) ;  $R_1=1$ ,  $R_2=2$ , the angle between two successive fins equals  $30^\circ$ . Ratio of fin thermal conductivity over fluid one is ten.

**Find:** Cross-sectional distributions of velocity and temperature, and  $fRe$ 、 $Nu$ .

**Solution:** The governing eq. for axial velocity:



$$\underbrace{\frac{1}{r} \frac{\partial}{\partial r} \left( r \eta \frac{\partial w}{\partial r} \right) + \frac{1}{r} \frac{\partial}{\partial \theta} \left( \frac{\eta}{r} \frac{\partial w}{\partial \theta} \right)}_{\text{div}(\eta \text{grad} w)} - \underbrace{\frac{dp}{dz}}_{\text{Source term}} = 0 \quad (\text{Polar coordinate})$$

Fig.1 Cross section view of Problem 4

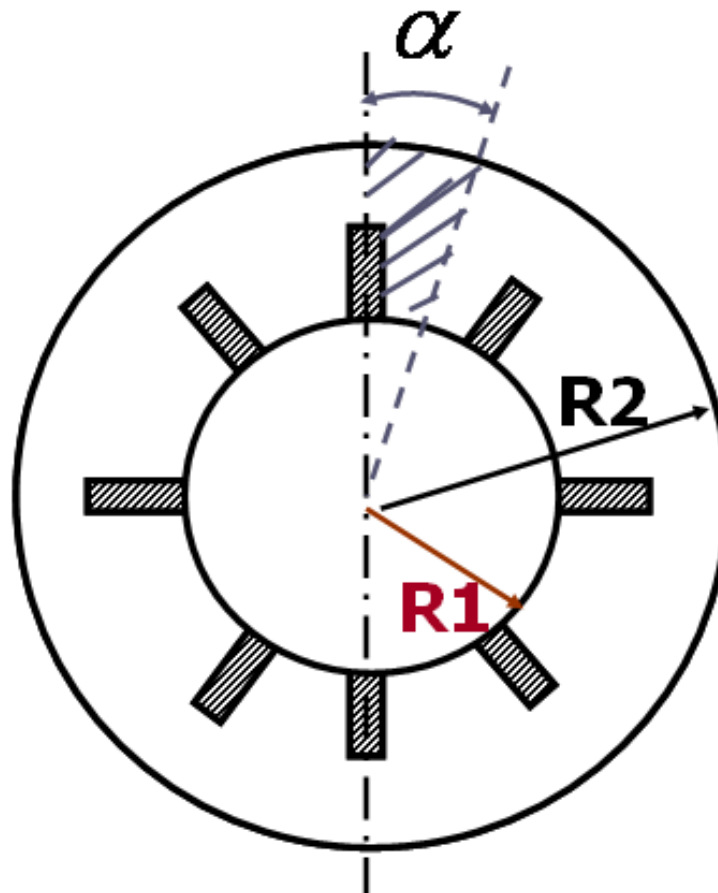

$$\frac{\lambda_{fin}}{\lambda_{fluid}} = 10$$

$$\frac{R_2}{R_1} = 2$$

$$\alpha = 15^\circ$$

The governing eq. of temperature in the fully developed region:

$$\text{div}(\lambda \text{grad}T) - \rho c_p w \frac{dT}{dz} = 0$$

Source term

## 9-4-2 Numerical methods

- (1) This problem is governed by two **conduction-type** equations with source term;
- (2) Velocity is not coupled with temperature, and can be solved first;
- (3) The fin can be regarded as a special fluid with a very large viscosity; hence the entire flow region can be solved **simultaneously---conjugated problem(耦合问题)** ;
- (4) The half of the region between two successive fins can be taken as computational domain because of symmetry;

5) In calculation of cross sectional temperature distribution it can assume that at the whole section  $\frac{\partial T}{\partial z} = C$

6) It is assumed that the fin surface coincides with radius.

7) The fin and fluid temperatures are solved at same time (simultaneously) --- conjugated problem

(耦合问题)

The fin shape has been modified a bit.

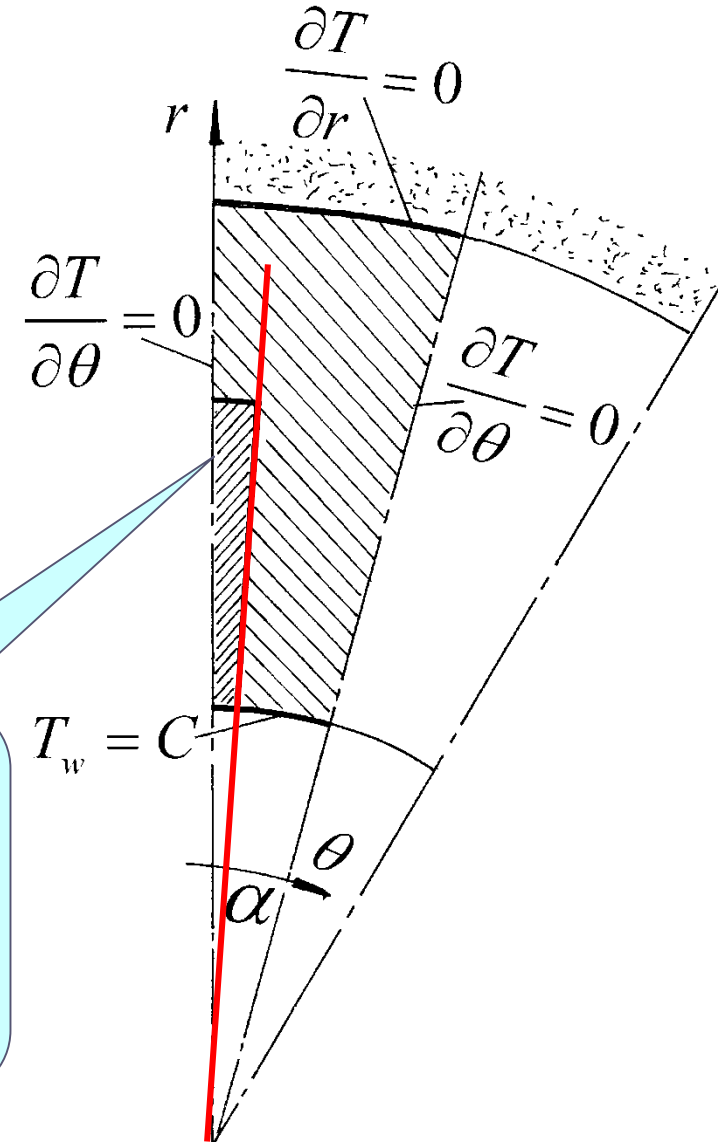

Fig. 2 Computational domain

## 9-4-3 Program reading

```
CCCCCCCCCCCCCCCCCCCCCCCCCCCCCCCCCCCCCCCCCCCCCCCCCCCCCCCC
MODULE USER_L
C*****
INTEGER*4 I, J
REAL*8 PI, TW, AMU, DPDZ, COND, RHOCP, DTDZ, WSUM, ASUM,
1 TSUM, AR, WBAR, WP, DH, RE, FRE, TBULK, HTP, HTC, ANU
END MODULE
CCCCCCCCCCCCCCCCCCCCCCCCCCCCCCCCCCCCCCCCCCCCCCCCCCCCCCCC
SUBROUTINE USER
C*****
USE START_L
USE USER_L
IMPLICIT NONE
C*****
C-----PROBLEM FOUR-----
C Fully developed laminar fluid flow and heat transfer in annular duct with
C-----longitudinal fins on inner tube-----
C*****
```

## ENTRY GRID

TITLE(4)='.THETA.'

TITLE(5)='.W/WBAR.'

LSOLVE(5)=.TRUE.

LPRINT(4)=.TRUE.

LPRINT(5)=.TRUE.

LAST=6

NTIMES(4)=4

NTIMES(5)=4

MODE=3 ! Polar coordinate

PI=3.14159

THL=15.\*PI/180. (从度转化为弧度)

YL=1.

R(1)=1. ! Specify the bottom radius

L1=7

M1=7

CALL UGRID

RETURN

! Velocity solved first, temperature next

! Both equations are linear, NTIMES  
may take larger values to decrease outer  
iteration times.

## ENTRY START

TW=1. ! Set up cross sectional wall temperature

DO 100 J=1,M1

DO 101 I=1,L1

F(I,J,4)=TW

F(I,J,5)=0.

} ! Initial fields of velocity and temperature

101 ENDDO

100 ENDDO

AMU=1. ! Very large viscosity to ensure laminar flow

DPDZ=-2000. ! Pressure gradient should be less than zero

RHOCP=1.

COND=1.

DTDZ=100. ! Set up axial gradient of fluid temperature

## RETURN

## ENTRY DENSE

## RETURN

! Empty, but keep it.

**ENTRY BOUND**

```

ASUM=0.
WSUM=0.
TSUM=0.
DO 300 J=2,M2
DO 301 I=2,L2
IF(I>2.OR.I=2 .AND.J>4) THEN
AR=YCVR(J)*THCV(I)
WSUM=WSUM+F(I,J,5)*AR
TSUM=TSUM+AR*F(I,J,4)*F(I,J,5)
ASUM=ASUM+AR
ENDIF
301 ENDDO
300 ENDDO
WBAR=WSUM/ASUM
WP=(R(1)+R(M1))*THL+(1.+THCV(2))*(RMN(5)-R(1))
DH=4.*ASUM/WP
RE=RHOCON*WBAR*DH/AMU
FRE=-2.*DPDZ*DH/(RHOCON*WBAR**2+1.E-30)*RE
    
```

! Initial values for summation

$$\begin{aligned}
 AR(\text{面积元}) &= YCV(j) * R(j) * XCV(i) \\
 &= YCV(j) * R(j) * THCV(i) \\
 &= YCVR(j) * THCV(i)
 \end{aligned}$$

! Exclude(排除) solid region for flow area

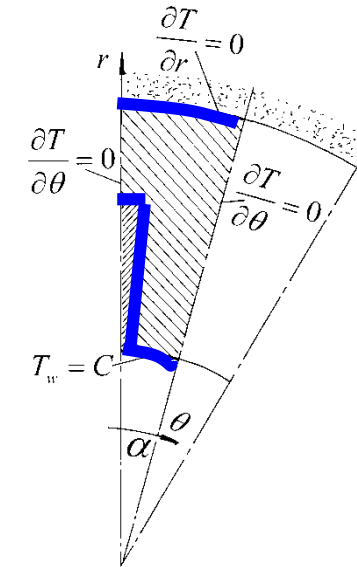

! Length of wetted perimeter(润湿边界的周长)

! Mean velocity

$$f Re = \frac{-(dp/dx) D_h}{(1/2) \rho w_m^2} Re$$

TBULK=TSUM/(WSUM+1.E-30) ! Mean temperature

HTP=WP-R(M1)\*THL ! Length of perimeter for heat transfer

HTC=RHOCP\*WSUM\*DTDZ/((TW-TBULK+1.E-30)\*HTP)

ANU=HTC\*DH/COND !  $Nu = hD_e / \lambda$

IF(ITER<3) RETURN

LSOLVE(5)=.TRUE. } Switch solution

LSOLVE(4)=.FALSE. } variable

RETURN

$$q = \rho c_p (W_m A \frac{\partial T}{\partial z}) \cdot 1 / (HTP \cdot 1)$$

$$h = q / (T_w - T_b)$$

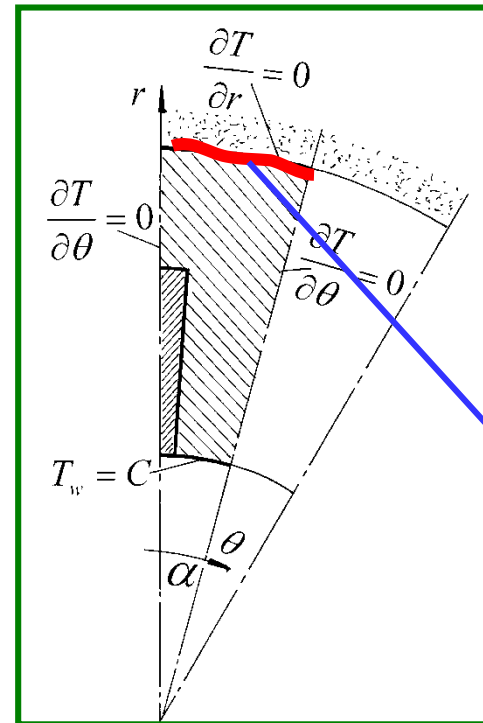

! This length is adiabatic, hence should be excluded in HTP.



## ENTRY OUTPUT

```
IF(ITER= =0) THEN
PRINT 401
WRITE(8,401)
401 FORMAT(1X,' ITER',12X,'F.RE',17X,'NU')
ELSE
PRINT 402, ITER, FRE, ANU
WRITE(8,402) ITER,FRE,ANU
402 FORMAT(1X,I6,1P2E20.4)
ENDIF
IF(ITER/=LAST) RETURN
DO 410 J=1,M1
DO 411 I=1,L1
F(I,J,5)=F(I,J,5)/WBAR
F(I,J,4)=(F(I,J,4)-TW)/(TBULK-TW+1.E-30)
411 ENDDO
410 ENDDO
CALL PRINT
RETURN
```

! Output of  
dimensionless  
results

$$\Theta = \frac{T - T_w}{T_b - T_w}; \quad \Theta_w = \frac{T_w - T_w}{T_b - T_w} = 0$$

## ENTRY GAMSOR

```

DO 500 I=1,L1
DO 501 J=1,M1
GAM(I,J)=AMU
IF(NF= =4) GAM(I,J)=COND ! GAMA for temperature
GAM(1,J)=0.
GAM(L1,J)=0. } ! Symmetric=adiabatic
IF(NF= =4) GAM(I,M1)=0. ! North boundary is adiabatic fo
IF(J<=4) GAM(2,J)=1.E10 !Fin is regarded as fluid with
IF(NF= =4.AND.J<=4) GAM(2,J)=10.*COND large viscosity
501 ENDDO ! Fin conductivity
500 ENDDO
DO 510 J=2,M2
DO 511 I=2,L2
CON(I,J)=-DPDZ ! Source term of W-eq., less than zero
IF(NF= =4) CON(I,J)=-DTDZ*F(I,J,4)*RHOCP
511 ENDDO
510 ENDDO
RETURN
END
    
```

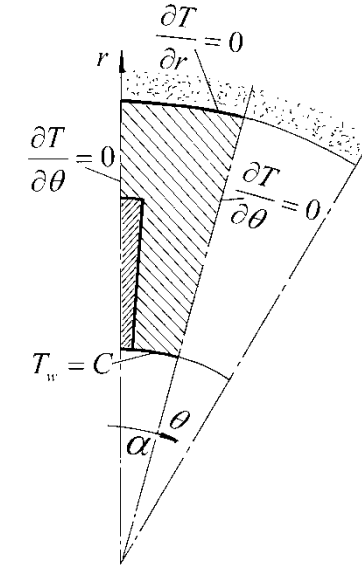

! Source of Temperature eq.

$$-\rho c_p w \frac{dT}{dz}$$

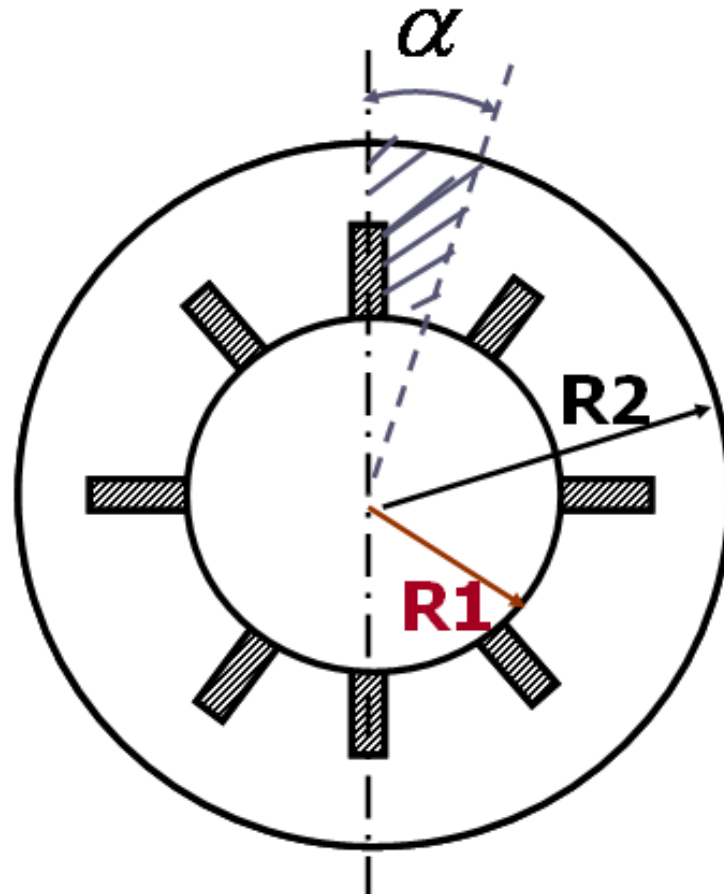

$$\frac{\lambda_{fin}}{\lambda_{fluid}} = 10$$

$$\frac{R_2}{R_1} = 2$$

$$\alpha = 15^\circ$$

Fig.1 Cross section view of Problem 4

# 9-4-4 Results analysis

## COMPUTATION IN POLAR COORDINATES

\*\*\*\*\*

ITER	F.RE	NU
0	0.0000E+00	0.0000E+00
1	6.5484E+01	1.9787E+10
2	6.5484E+01	2.3588E+33
3	6.5484E+01	2.3588E+33
4	6.5484E+01	1.5098E+00
5	6.5484E+01	1.5098E+00
6	6.5484E+01	1.5098E+00

Solving flow only

! NTIMES=4 ,  
only one outer iteration  
solution is converged

! NTIMES=4 , only  
one outer iteration  
solution is converged

(E)

\*\*\*\*\*.W/WBAR.\*\*\*\*\*

I =	1	2	3	4	5	6	7
J							
7	0.00E+00	0.00E+00	0.00E+00	0.00E+00	0.00E+00	0.00E+00	0.00E+00
6	0.00E+00	8.18E-01	8.50E-01	8.91E-01	9.25E-01	9.43E-01	0.00E+00
5	0.00E+00	1.10E+00	1.30E+00	1.50E+00	1.64E+00	1.72E+00	0.00E+00
4	0.00E+00	4.37E-09	4.57E-01	1.05E+00	1.41E+00	1.58E+00	0.00E+00
3	0.00E+00	3.34E-09	3.01E-01	7.45E-01	1.03E+00	1.18E+00	0.00E+00
2	0.00E+00	1.43E-09	1.63E-01	3.91E-01	5.36E-01	6.06E-01	0.00E+00
1	0.00E+00	0.00E+00	0.00E+00	0.00E+00	0.00E+00	0.00E+00	0.00E+00

W=0 of fin region

Symmetric line, not decorated.

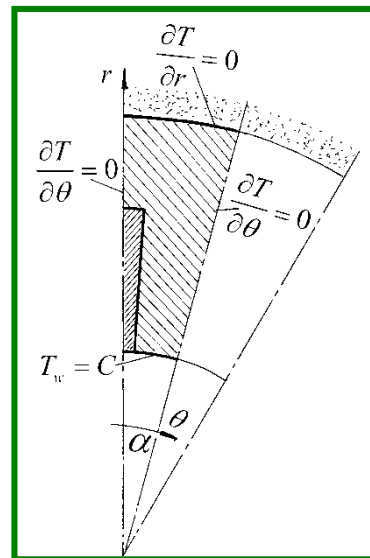

Symmetric line, not decorated

\*\*\*\*\* THETA \*\*\*\*\*

Adiabatic, not decorated

I =	1	2	3	4	5	6	7
J							
7	0.00E+00	0.00E+00	0.00E+00	0.00E+00	0.00E+00	0.00E+00	0.00E+00
6	0.00E+00	1.24E+00	1.26E+00	1.28E+00	1.30E+00	1.31E+00	0.00E+00
5	0.00E+00	1.03E+00	1.09E+00	1.15E+00	1.19E+00	1.21E+00	0.00E+00
4	0.00E+00	6.34E-01	7.15E-01	8.24E-01	8.96E-01	9.32E-01	0.00E+00
3	0.00E+00	4.48E-01	4.80E-01	5.36E-01	5.78E-01	6.00E-01	0.00E+00
2	0.00E+00	1.76E-01	1.86E-01	2.04E-01	2.18E-01	2.26E-01	0.00E+00
1	0.00E+00	0.00E+00	0.00E+00	0.00E+00	0.00E+00	0.00E+00	0.00E+00

$$\Theta = \frac{T - T_w}{T_b - T_w} = 0$$

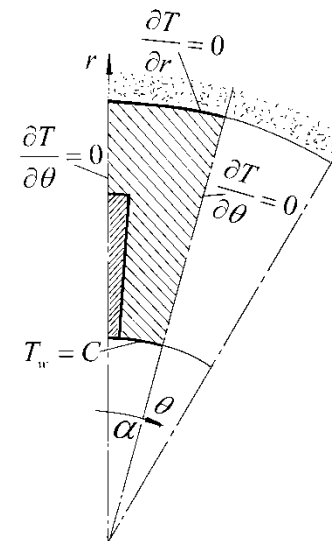

Symmetric  
line, not  
decorated.

Symmetric  
line, not  
decorated

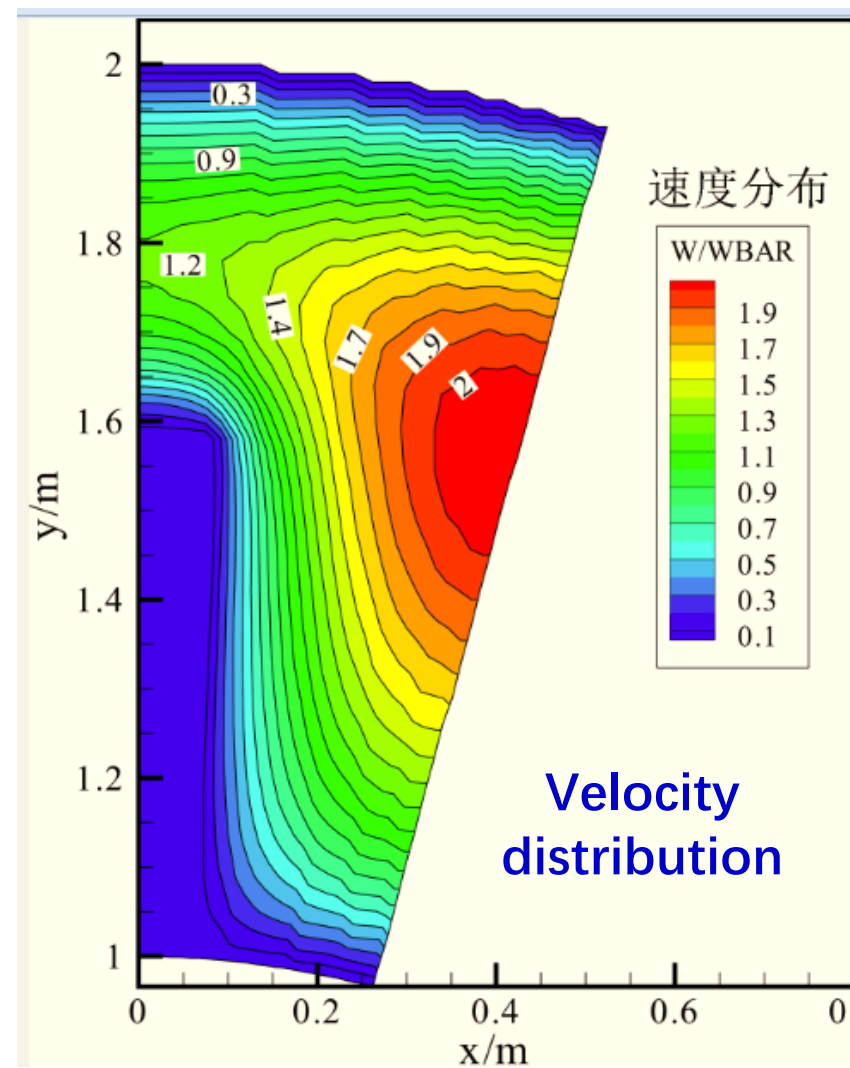
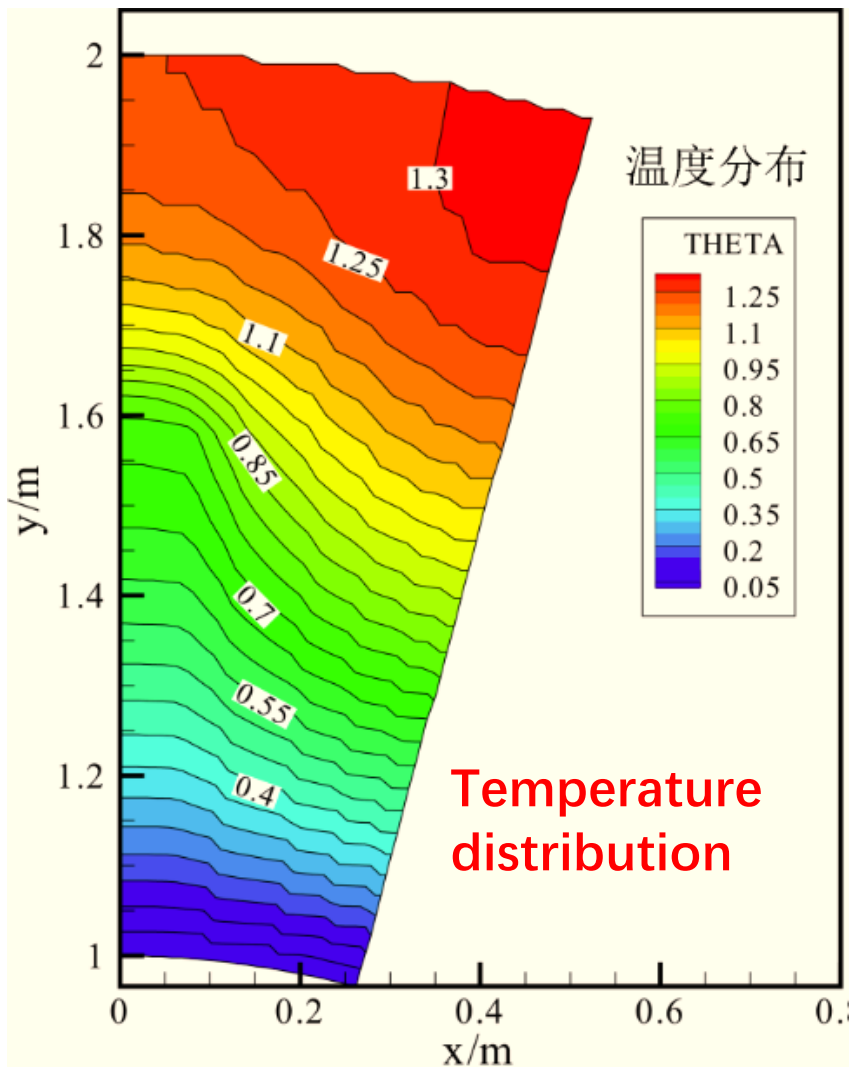

Fig.3 Result of Problem 4

## 9-5 Fluid flow and heat transfer in a 2-D sudden expansion- --Solution of Navier Stokes equation

### 9-5-1 Physical problem and its math formulation

**Known:** Laminar flow and heat transfer in a parallel duct shown in Fig. 1 : Uniform inlet velocity,  $V_{in}=100$ , and uniform inlet temperature,  $T_{in}=50$ ; Duct wall are at uniform temperature,  $T_w=300$ . Fluid  $Pr=0.7$ , molecular dynamic viscosity  $\mu=1$ , density varies according to:

$$\rho = \rho_{ref} \frac{T_{ref}}{T}$$

where referenced density  $\rho_{ref}=1$ , and referenced temperature  $T_{ref}=300$ .



**Find:** Distributions of velocity, temperature, density and fluid pressure in the duct.

$$V_{in} = 100$$

$$T_{in} = 500$$

$$T_w = 300$$

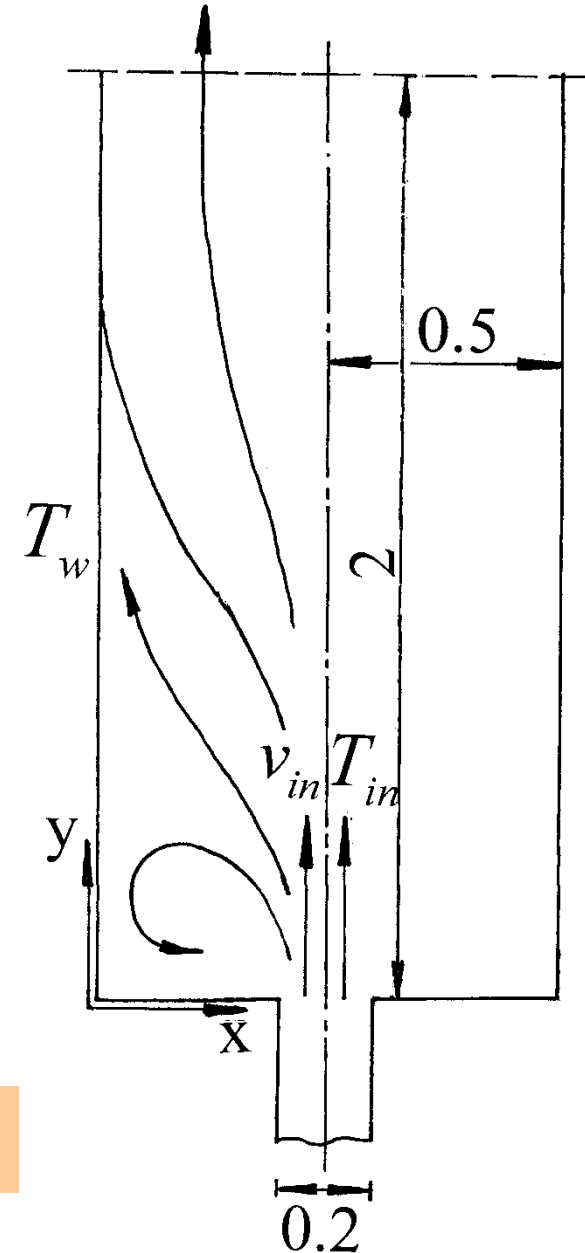

Fig. 1 of Problem 5

The governing equations of velocity and temperature:

$$u: \operatorname{div}(\rho \vec{u} u) = -\frac{\partial p}{\partial x} + \operatorname{div}(\eta \operatorname{grad} u) + 0$$

$$v: \operatorname{div}(\rho \vec{u} v) = -\frac{\partial p}{\partial y} + \operatorname{div}(\eta \operatorname{grad} v) + 0$$

$$T: \operatorname{div}(\rho c_p \vec{u} T) = \operatorname{div}(\lambda \operatorname{grad} T) + 0$$

Boundary conditions:

At symmetric line:  $u = 0; \frac{\partial v}{\partial x} = 0; \frac{\partial T}{\partial x} = 0$

At inlet:  $u, v, T$  are specified;

At solid wall:  $u = v = 0; T = T_w$

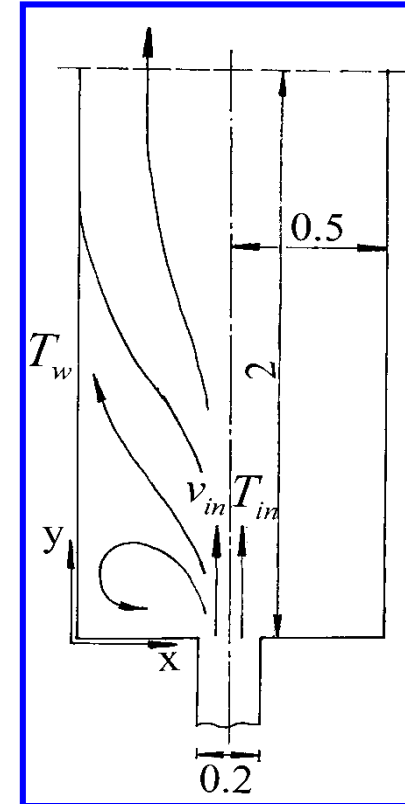

## 9-5-2 Numerical methods

(1) This is an open-flow system. Determination of normal velocity at the outlet boundary for open flow field is important: Set the outlet boundary in region without recirculation, adopt local one-way method with total mass conservation;

(2) Convergence condition for flow field iteration: SSUM and SMAX less than pre-specified values or 4 to 5 digits remain unchanged during 5 to 10 successive iterations;

(3) Variation of density with temperature is specified in **ENTRY DENSE**.

# 9-5-3 Program reading

```

CCCCCCCCCCCCCCCCCCCCCCCCCCCCCCCCCCCCCCCCCCCCCCCCCCCCCCCC
MODULE USER_L
C*****
INTEGER*4 I,J
REAL*8 TIN, TW, VIN, VOUT, PR, AMU, COND, TREF, RHOREF,
1 RHOT, FLOWIN, FL, FACTOR
END MODULE
CCCCCCCCCCCCCCCCCCCCCCCCCCCCCCCCCCCCCCCCCCCCCCCCCCCCCCCC
SUBROUTINE USER
C*****
USE START_L
USE USER_L
IMPLICIT NONE
C*****
C----- -PROBLEM SIX-----
C Laminar fluid flow and heat transfer in a two-dimensional sudden expansion
C-----
C*****

```

!Difference in section number and problem number:  
!Section No is five;  
!Prob. No. of the original code-6



C

**ENTRY GRID**
**LAST=60**

TITLE(1)=' .VEL U.'

TITLE(2)=' .VEL V.'

TITLE(3)=' .STR FN.'

TITLE(4)=' .TEMP.'

TITLE(11)='PRESSURE'

TITLE(12)=' DENSITY'

' VEL\_U'

' VEL\_V'

' STR\_FN'

' TEMP.'

'PRESSURE'

' DENSITY'

Titles for print out

RELAX(1)=0.8! Underrelaxation of velocity is organized in the solution process.

RELAX(2)=0.8

LSOLVE(1)=.TRUE. ! For SIMPLER set .TRUE. For NF=1 is enough

LSOLVE(4)=.TRUE.

LPRINT(1)=.TRUE.

LPRINT(2)=.TRUE.

LPRINT(3)=.TRUE.

LPRINT(4)=.TRUE.

LPRINT(11)=.TRUE.

LPRINT(12)=.TRUE.

LAST= 60

XL=0.5

YL=2.

L1=7

M1=12

CALL UGRID

**RETURN**

**ENTRY START**

```

TIN=500
TW=300.
VIN=100.
VOU=VIN*XCV(L2)/X(L1)*TW/TIN
DO 100 J=1,M1
DO 101 I=1,L1
U(I,J)=0
V(I,J)=VOU
V(I,2)=0
V(1,J)=0.
T(I,J)=TW
101 ENDDO
100 ENDDO
V(L2,2)=VIN
T(L2,1)=TIN
PR=.7
AMU=1.
AMUP=AMU*CPCON/PR
TREF=300.
RHOREF=1.
RHOT=RHOREF*TREF

```

! Initial field, including some boundary conditions.

! At the same location, different i, and j for V and T

$$Pr = \mu c_p / \lambda$$

$$\lambda = \mu c_p / Pr$$

! Estimation of outlet normal velocity

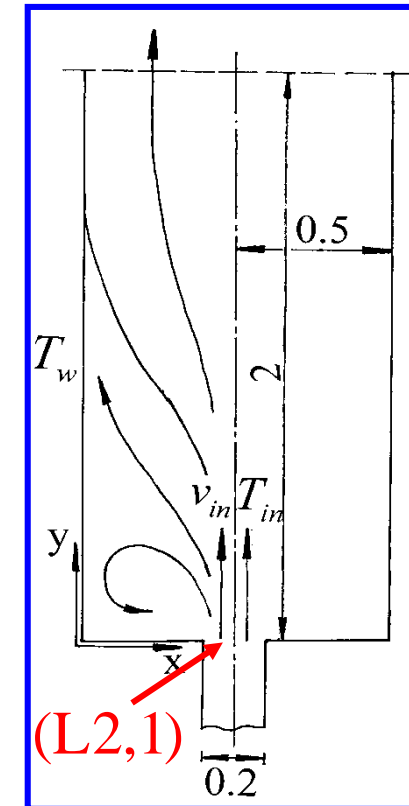

**RETURN**

## Total mass conservation for case of outlet without recirculation

- Assuming that relative changes of outlet normal velocity = constant

$$\frac{v_{i,M1} - v_{i,M2}}{v_{i,M2}} = k = \text{const}$$

$$v_{i,M1} = v_{i,M2}(1 + k) = f v_{i,M2}$$

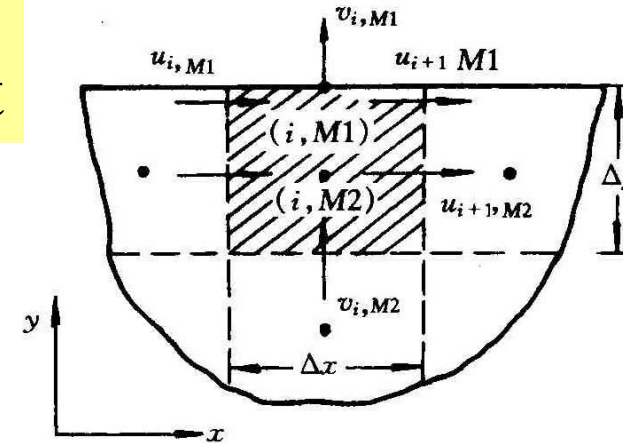

$f$  is determined according to total mass conservation :

$$\sum_{i=2}^{L2} \rho_{i,M1} v_{i,M1} \Delta x_i = \sum_{i=2}^{L2} \rho_{i,M1} f v_{i,M2} \Delta x_i = \text{FLOWIN}$$

$$f = \frac{\text{FLOWIN}}{\sum_{i=2}^{L2} \rho_{i,M1} v_{i,M2} \Delta x_i}$$

$$v_{i,M1} = f \bullet v_{i,M2}^*$$

It is regarded as the boundary condition for next iteration.

(2) Assuming that the 1<sup>st</sup> derivatives at outlet = constant

$$\frac{v_{i,M1} - v_{i,M2}}{\Delta y} = k = \text{const} \longrightarrow v_{i,M1} = v_{i,M2} + k\Delta y = v_{i,M2} + C$$

C is determined according to total mass conservation

$$\sum_{i=2}^{L2} \rho_{i,M1} (v_{i,M2} + C) \Delta x_i = \text{FLOWIN} \longrightarrow$$

$$C = \frac{\text{FLOWIN} - \sum \rho_{i,M1} v_{i,M2} \Delta x_i}{\sum \rho_{i,M1} \Delta x_i}$$

$v_{i,M1} = v_{i,M2}^* + C$  is taking as boundary condition for next iteration.

When fully developed at outlet, :  $f=1, C=0$ ;  
 Otherwise there is some differences between the two treatments. In this example FACTOR method will be used



**ENTRY DENSE**

```
DO 200 J=1,M1
DO 201 I=1,L1
RHO(I,J)=RHOT/T(I,J)
201 ENDDO
200 ENDDO
```

**! Variable density**

**! RHOT=RHOREF\*TREF**

**RETURN**

\*

**ENTRY BOUND**

**!Inlet flow rate calculation**

```
IF(ITER= =0) FLOWIN=RHO(L2,1)*V(L2,2)*XCV(L2)
FL=0.
```

```
DO 301 I=2,L2
FL=FL+RHO(I,M1)*V(I,M2)*XCV(I)
```

**!Outlet flow rate calculation**

```
301 ENDDO
FACTOR=FLOWIN/FL
DO 302 I=2,L2
V(I,M1)=V(I,M2)*FACTOR
T(I,M1)=T(I,M2)
```

$$\text{Factor} = \frac{\text{FLOWIN}}{\sum_{i=2}^{L2} \rho_{i,M1} * V_{i,M2} * XCV(i)}$$

**RETURN**

Only for print out purpose—decoration! It can be executed after getting converged solution.

## ENTRY OUTPUT

```
IF(ITER= =0) THEN
WRITE(8,401)
401 FORMAT(1X,' ITER',7X,'SMAX',11X,'SSUM',10X,'V(4,7)',
1 9X,'T(4,7)')
ELSE
PRINT 403, ITER, SMAX, SSUM, V(4,7), T(4,7)
WRITE(8,403) ITER, SMAX, SSUM, V(4,7), T(4,7)
403 FORMAT(1X,I6,1P4E15.3)
ENDIF
IF (ITER= =LAST) CALL PRINT
RETURN
```

Print out **SMAX,SSUM** for observing the convergence of the iteration

\*

## ENTRY GAMSOR

DO 500 J=1,M1

DO 501 I=1,L1

GAM(I,J)=AMU

IF(NF/=4) GAM(I,J)=AMUP ! For solving temperature

IF(NF/=1) GAM(L1,J)=0.! Except u others ---adiabatic

GAM(I,M1)=0. ! Local one way for both u and T,

501 ENDDO identical to adiabatic.

500 ENDDO

**RETURN**

END

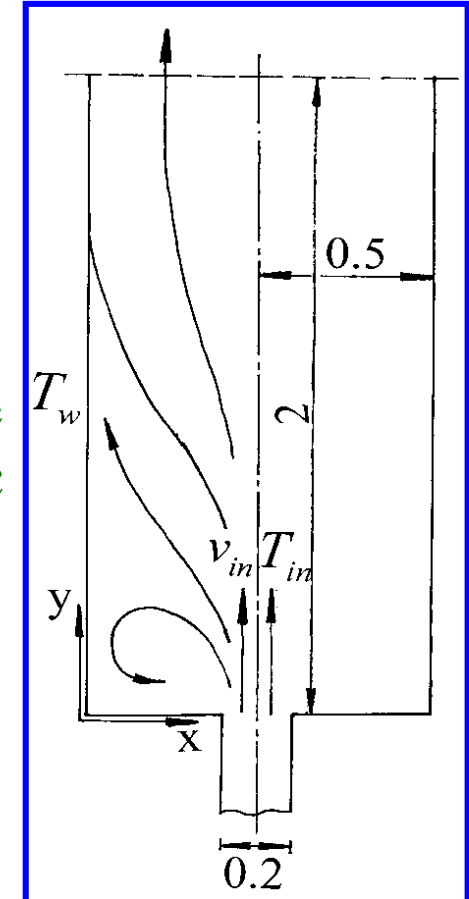

## 9-5-4 Results analysis

### COMPUTATION IN CARTISIAN COORDINATES

\*\*\*\*\*

ITER	SMAX	SSUM	V(4,7)	T(4,7)
0	0.000E+00	0.000E+00	1.200E+01	3.000E+02
1	2.366E+00	5.960E-08	1.205E+01	3.559E+02
2	1.068E+00	3.576E-07	1.526E+01	3.574E+02
3	1.059E+00	-2.980E-07	1.600E+01	3.609E+02
4	6.520E-01	-8.941E-08	1.609E+01	3.630E+02
5	1.605E-01	4.433E-07	1.618E+01	3.645E+02
6	1.039E-01	-8.754E-08	1.606E+01	3.655E+02
7	5.972E-02	-8.196E-08	1.594E+01	3.663E+02
8	3.817E-02	-3.101E-07	1.576E+01	3.668E+02
9	2.447E-02	-5.243E-07	1.559E+01	3.672E+02
10	1.535E-02	2.674E-07	1.543E+01	3.675E+02
11	9.663E-03	-8.473E-07	1.529E+01	3.677E+02
12	5.899E-03	4.657E-10	1.516E+01	3.678E+02

Total mass conservation is artificially made!

			!V(4,7)	!T(4,7)
13	4.332E-03	-2.432E-07	1.506E+01	3.678E+02
14	3.456E-03	2.751E-07	1.498E+01	3.678E+02
15	2.698E-03	7.753E-08	1.491E+01	3.678E+02
16	2.052E-03	1.475E-07	1.486E+01	3.678E+02
17	1.539E-03	-5.428E-07	1.481E+01	3.678E+02
18	1.133E-03	2.519E-07	1.478E+01	3.677E+02
19	8.994E-04	2.108E-07	1.476E+01	3.677E+02
20	7.056E-04	5.479E-07	1.474E+01	3.677E+02
21	5.436E-04	2.256E-07	1.473E+01	3.677E+02
22	4.111E-04	9.380E-08	1.472E+01	3.676E+02
23	3.100E-04	1.485E-07	1.471E+01	3.676E+02
24	2.303E-04	2.160E-07	1.470E+01	3.676E+02
25	1.793E-04	4.192E-07	1.470E+01	3.676E+02
26	1.447E-04	-1.086E-08	1.470E+01	3.676E+02
27	1.149E-04	-9.684E-08	1.469E+01	3.676E+02
28	8.990E-05	1.732E-09	1.469E+01	3.676E+02
29	6.926E-05	-5.815E-07	1.469E+01	3.676E+02
30	5.170E-05	-3.065E-07	1.469E+01	3.676E+02
31	3.837E-05	-5.491E-07	1.469E+01	3.676E+02
32	3.084E-05	2.732E-07	1.469E+01	3.676E+02

33	2.032E-05	-9.269E-07	1.469E+01	3.676E+02
34	2.015E-05	3.659E-08	1.469E+01	3.676E+02
35	1.213E-05	4.555E-07	1.469E+01	3.676E+02
36	9.591E-06	-1.184E-07	1.469E+01	3.676E+02
37	6.249E-06	4.063E-07	1.469E+01	3.676E+02
38	4.888E-06	-2.038E-08	1.469E+01	3.676E+02
39	3.099E-06	1.491E-07	1.469E+01	3.676E+02
40	3.695E-06	4.564E-07	1.469E+01	3.676E+02
41	2.980E-06	-3.393E-07	1.469E+01	3.676E+02
42	2.923E-06	1.307E-06	1.469E+01	3.676E+02
43	3.150E-06	-3.455E-07	1.469E+01	3.676E+02
44	2.787E-06	5.100E-07	1.469E+01	3.676E+02
45	3.219E-06	-2.657E-07	1.469E+01	3.676E+02
46	2.980E-06	-8.977E-07	1.469E+01	3.676E+02
47	2.503E-06	-2.419E-07	1.469E+01	3.676E+02
48	2.205E-06	5.658E-08	1.469E+01	3.676E+02
49	3.517E-06	-9.167E-07	1.469E+01	3.676E+02
50	3.576E-06	-1.444E-07	1.469E+01	3.676E+02
51	3.278E-06	2.954E-07	1.469E+01	3.676E+02

52	2.772E-06	1.221E-08	1.469E+01	3.676E+02
53	2.146E-06	5.844E-07	1.469E+01	3.676E+02
54	2.104E-06	5.236E-07	1.469E+01	3.676E+02
55	2.921E-06	3.407E-07	1.469E+01	3.676E+02
56	2.712E-06	1.156E-07	1.469E+01	3.676E+02
57	2.801E-06	2.216E-07	1.469E+01	3.676E+02
58	3.005E-06	8.967E-08	1.469E+01	3.676E+02
59	2.886E-06	4.362E-07	1.469E+01	3.676E+02
60	2.623E-06	5.034E-07	1.469E+01	3.676E+02

That SMAX reduces to a certain value can be regarded as an indicator of convergence

In the iteration process SSUM takes a very small value from beginning to the end. This can not be regarded as an indicator of convergence. Because it is resulted by our treatment of outflow boundary condition!

\*\*\*\*\* .VEL U. \*\*\*\*\*

I =	2	3	4	5	6	7
J						No decoration
12	0.00E+00	0.00E+00	0.00E+00	0.00E+00	0.00E+00	0.00E+00
11	0.00E+00	1.41E-02	3.39E-02	4.04E-02	2.71E-02	0.00E+00
10	0.00E+00	-6.73E-02	-1.96E-01	-2.78E-01	-2.11E-01	0.00E+00
9	0.00E+00	-1.55E-01	-4.33E-01	-5.97E-01	-4.48E-01	0.00E+00
8	0.00E+00	-3.26E-01	-8.75E-01	-1.19E+00	-8.95E-01	0.00E+00
7	0.00E+00	-6.17E-01	-1.61E+00	-2.16E+00	-1.65E+00	0.00E+00
6	0.00E+00	-1.03E+00	-2.62E+00	-3.53E+00	-2.75E+00	0.00E+00
5	0.00E+00	-1.42E+00	-3.67E+00	-5.06E+00	-4.10E+00	0.00E+00
4	0.00E+00	-1.35E+00	-3.91E+00	-5.02E+00	-5.42E+00	0.00E+00
3	0.00E+00	1.37E-01	-1.24E+00	-6.69E+00	-6.33E+00	0.00E+00
2	0.00E+00	2.64E+00	6.16E+00	1.03E+00	-7.70E+00	0.00E+00
1	0.00E+00	0.00E+00	0.00E+00	0.00E+00	0.00E+00	0.00E+00



u larger than 0

u less than 0



\*\*\*\*\* .VEL V. \*\*\*\*\*

I =	1	2	3	4	5	6	7
J							
12	0.00E+00	3.73E+00	9.97E+00	1.50E+01	1.87E+01	2.07E+01	1.20E+01
11	0.00E+00	3.76E+00	1.01E+01	1.52E+01	1.89E+01	2.09E+01	1.20E+01
10	0.00E+00	3.65E+00	9.94E+00	1.53E+01	1.95E+01	2.19E+01	1.20E+01
9	0.00E+00	3.37E+00	9.57E+00	1.54E+01	2.04E+01	2.35E+01	1.20E+01
8	0.00E+00	2.76E+00	8.70E+00	1.52E+01	2.17E+01	2.61E+01	1.20E+01
7	0.00E+00	1.59E+00	7.02E+00	1.47E+01	2.35E+01	3.03E+01	1.20E+01
6	0.00E+00	-3.65E-01	4.21E+00	1.36E+01	2.60E+01	3.70E+01	1.20E+01
5	0.00E+00	-3.06E+00	1.81E-01	1.15E+01	2.89E+01	4.66E+01	1.20E+01
4	0.00E+00	-5.60E+00	-4.41E+00	8.01E+00	3.09E+01	5.93E+01	1.20E+01
3	0.00E+00	-5.24E+00	-6.77E+00	1.43E+00	2.77E+01	7.51E+01	1.20E+01
2	0.00E+00	0.00E+00	0.00E+00	0.00E+00	0.00E+00	1.00E+02	0.00E+00

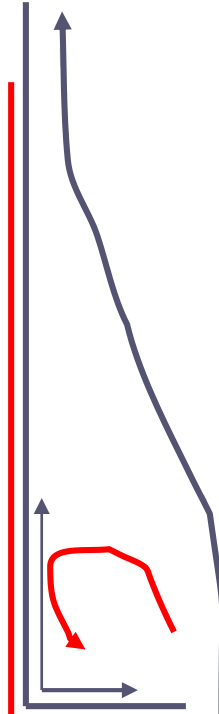

v less than 0

V larger than 0

Inlet V

No decoration

\*\*\*\*\* .STR FN. \*\*\*\*\*

I =	2	3	4	5	6	7
J						
12	0.00E+00	-3.63E-01	-1.29E+00	-2.63E+00	-4.24E+00	-6.00E+00
11	0.00E+00	-3.66E-01	-1.29E+00	-2.63E+00	-4.25E+00	-6.00E+00
10	0.00E+00	-3.53E-01	-1.26E+00	-2.58E+00	-4.21E+00	-6.00E+00
9	0.00E+00	-3.24E-01	-1.18E+00	-2.48E+00	-4.14E+00	-6.00E+00
8	0.00E+00	-2.64E-01	-1.03E+00	-2.29E+00	-4.00E+00	-6.00E+00
7	0.00E+00	-1.51E-01	-7.61E-01	-1.95E+00	-3.74E+00	-6.00E+00
6	0.00E+00	3.46E-02	-3.26E-01	-1.40E+00	-3.34E+00	-6.00E+00
5	0.00E+00	2.89E-01	2.74E-01	-6.28E-01	-2.74E+00	-6.00E+00
4	0.00E+00	5.31E-01	9.10E-01	2.79E-01	-1.97E+00	-6.00E+00
3	0.00E+00	5.06E-01	1.12E+00	9.96E-01	-1.09E+00	-6.00E+00
2	0.00E+00	0.00E+00	0.00E+00	0.00E+00	0.00E+00	-6.00E+00

Stream function =0  
at the wall

Total flow rate

\*\*\*\*\* . TEMP . \*\*\*\*\*

I =	1	2	3	4	5	6	7
J							
12	3.00E+02	3.08E+02	3.23E+02	3.37E+02	3.48E+02	3.53E+02	3.00E+02
11	3.00E+02	3.08E+02	3.23E+02	3.37E+02	3.48E+02	3.53E+02	3.00E+02
10	3.00E+02	3.09E+02	3.27E+02	3.43E+02	3.55E+02	3.62E+02	3.00E+02
9	3.00E+02	3.11E+02	3.31E+02	3.50E+02	3.65E+02	3.73E+02	3.00E+02
8	3.00E+02	3.12E+02	3.37E+02	3.59E+02	3.75E+02	3.84E+02	3.00E+02
7	3.00E+02	3.14E+02	3.43E+02	3.68E+02	3.87E+02	3.97E+02	3.00E+02
6	3.00E+02	3.16E+02	3.48E+02	3.76E+02	3.98E+02	4.10E+02	3.00E+02
5	3.00E+02	3.18E+02	3.53E+02	3.83E+02	4.07E+02	4.23E+02	3.00E+02
4	3.00E+02	3.18E+02	3.53E+02	3.85E+02	4.12E+02	4.35E+02	3.00E+02
3	3.00E+02	3.15E+02	3.45E+02	3.76E+02	4.10E+02	4.49E+02	3.00E+02
2	3.00E+02	3.06E+02	3.21E+02	3.42E+02	3.88E+02	4.69E+02	3.00E+02
1	3.00E+02	3.00E+02	3.00E+02	3.00E+02	3.00E+02	5.00E+02	3.00E+02

Decoration has been made :  
T(I,M1)=T(I,M2)

Given wall temperature

Inlet temp.

No decoration

\*\*\*\*\* PRESSURE \*\*\*\*\*

I =	1	2	3	4	5	6	7
J							
12	8.40E+02	8.40E+02	8.39E+02	8.38E+02	8.34E+02	8.31E+02	8.30E+02
11	8.52E+02	8.52E+02	8.52E+02	8.50E+02	8.48E+02	8.45E+02	8.44E+02
10	8.77E+02	8.77E+02	8.76E+02	8.76E+02	8.75E+02	8.74E+02	8.73E+02
9	8.99E+02	8.98E+02	8.97E+02	8.95E+02	8.94E+02	8.92E+02	8.91E+02
8	<b>9.12E+02</b>	9.10E+02	9.08E+02	9.06E+02	9.05E+02	9.02E+02	9.00E+02
7	9.06E+02	9.04E+02	9.01E+02	8.99E+02	8.99E+02	8.96E+02	8.94E+02
6	8.63E+02	8.61E+02	8.56E+02	8.56E+02	8.62E+02	8.59E+02	8.58E+02
5	7.55E+02	7.52E+02	7.46E+02	7.50E+02	7.66E+02	7.69E+02	7.70E+02
4	5.57E+02	5.53E+02	5.45E+02	5.50E+02	5.85E+02	6.02E+02	6.11E+02
3	2.91E+02	2.84E+02	2.72E+02	2.55E+02	3.32E+02	3.56E+02	3.68E+02
2	9.85E+01	8.74E+01	6.54E+01	-3.27E+01	-2.08E+02	9.08E+01	2.40E+02
1	0.00E+00	-1.10E+01	-3.79E+01	-1.77E+02	-4.78E+02	-4.18E+01	1.07E+02

Maximum pressure caused by reattachment of flow

Low pressure region caused by high inlet velocity

From interpolation

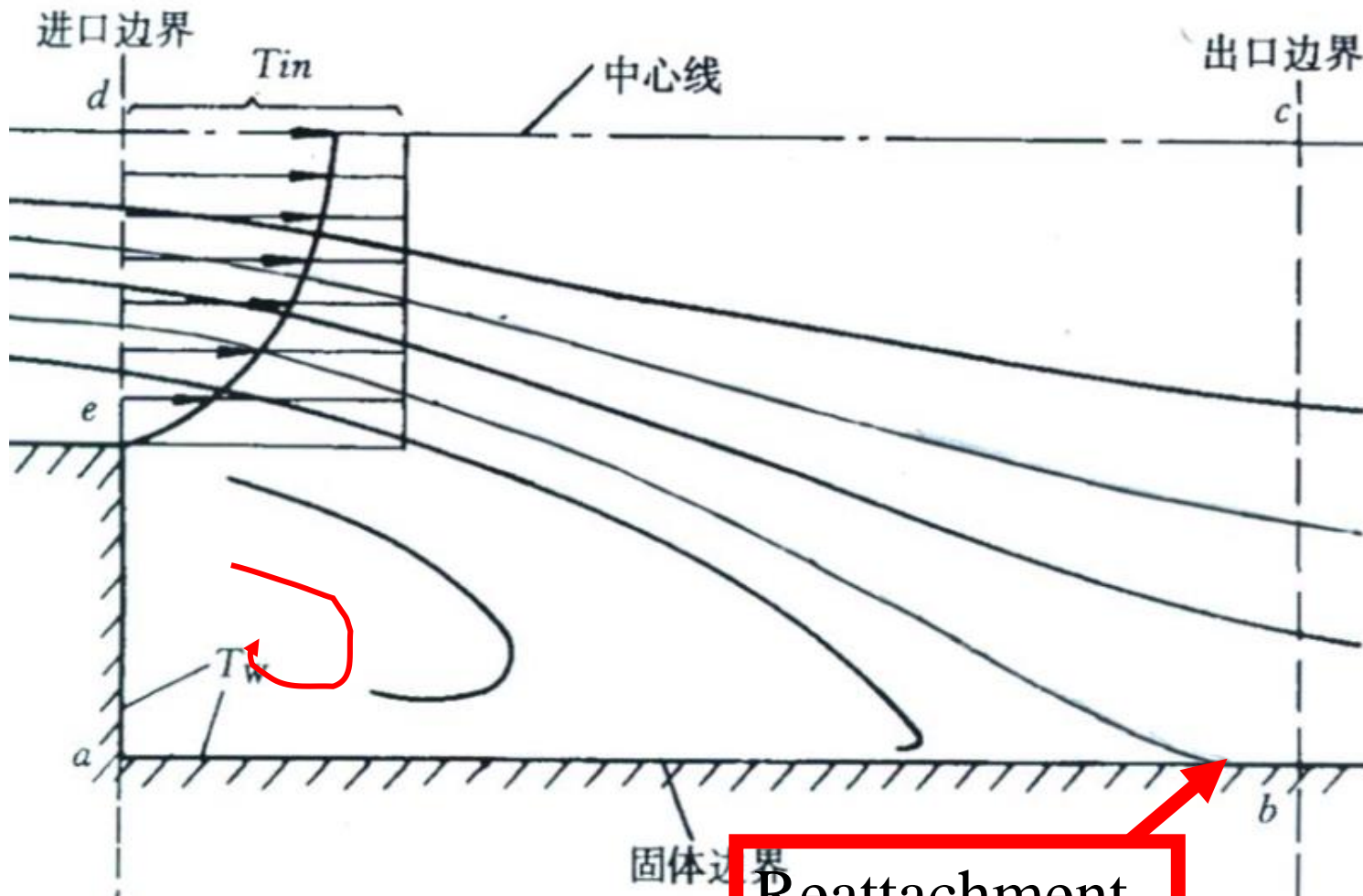

Fig.2 of Problem 6

Reattachment Point,  $p = p_{max}$

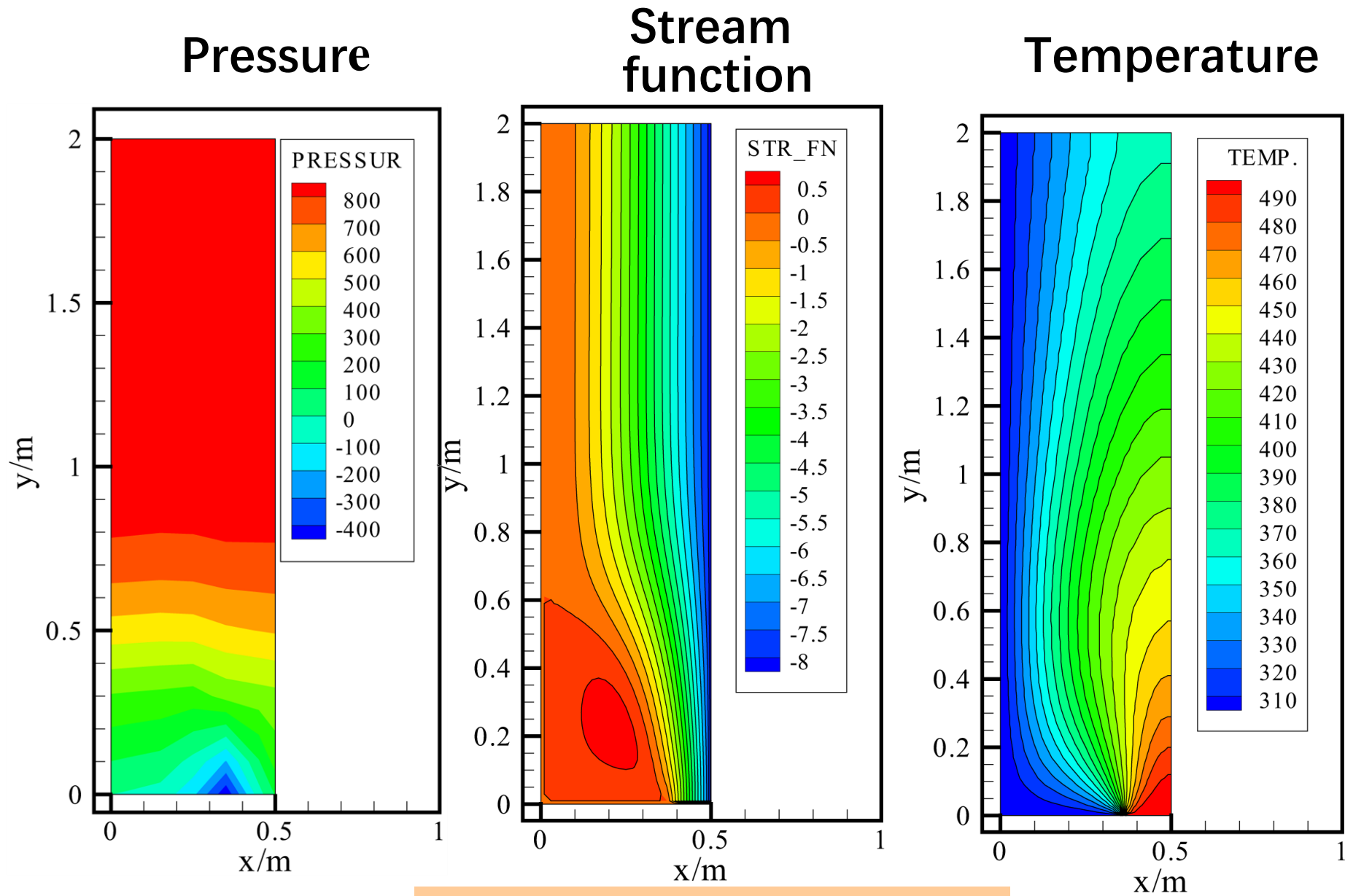

Fig. 3 Results of Problem 6

## 9-6 Complicated fully developed fluid flow and heat transfer in square duct

---Velocity is regarded as a  $\phi$  variable

### 9-6-1 Physical problem and its math formulation

**Known:** Fully developed heat transfer in a square duct shown in Fig. 1. The effect of gravitation is taken into account by Boussinesq assumption. Duct top and bottom walls are adiabatic, while left and right walls are kept at constant and uniform temperatures:  $T_1=T_c=0$ ,  $T_2=T_h=1$ ;  $Pr=0.7$ ,  $AMU=1.0$ ,  $dp/dz=-3000$ , and  $\rho g \beta = 10^4$ .

**Find:** Cross sectional distributions of  $u$ ,  $v$ , and  $w$ , temperature distribution and  $fRe$ .

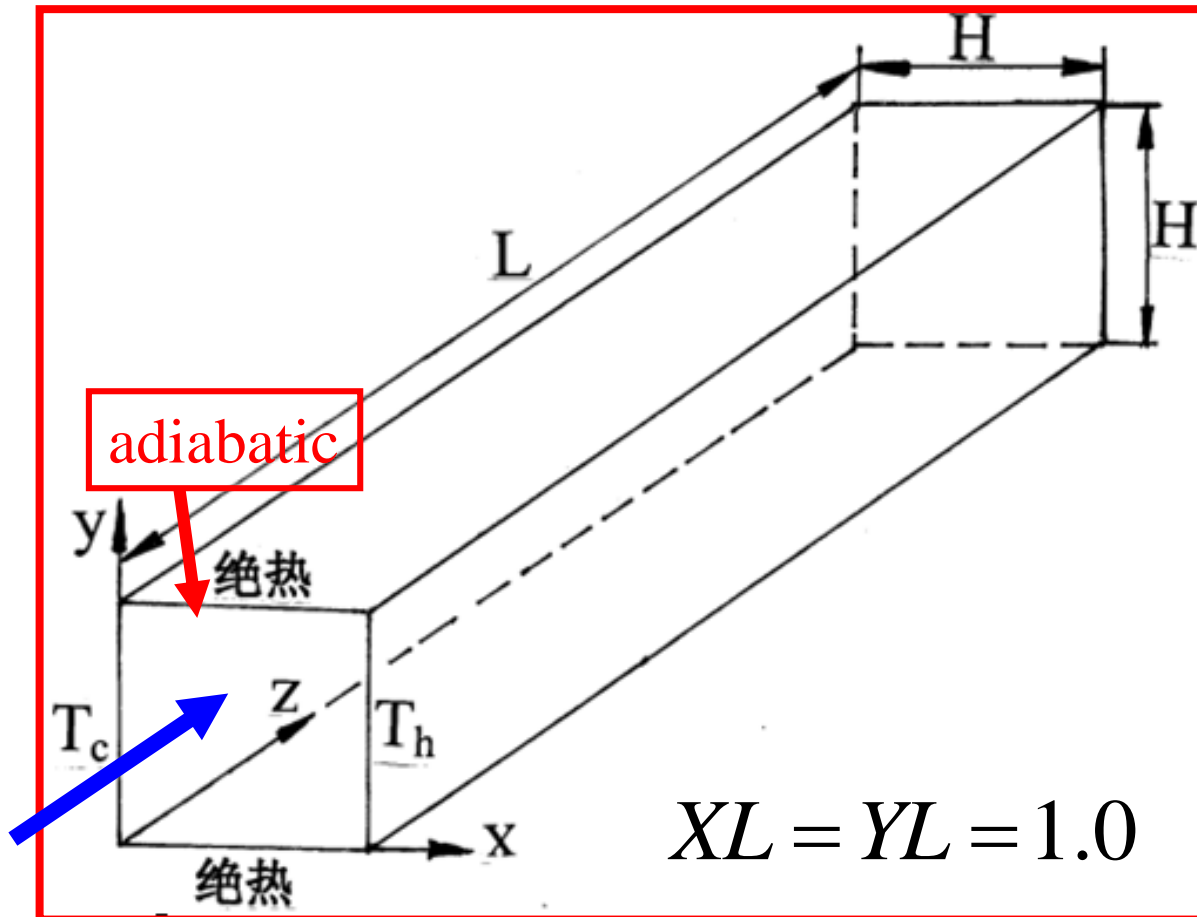

Fig. 1 Physical model of Problem 6

For the case studied, when heat transfer goes into the fully developed region, the heat leaves the hot wall goes into the cold wall, i.e., the heat transfer rate is determined by the flow at the cross-section, and **the axial flow does not make any contribution to this heat transfer.**



## Analysis of the governing eq.:

According to the fully developed condition

$$\rho\left(u \frac{\partial u}{\partial x} + v \frac{\partial u}{\partial y} + w \frac{\partial u}{\partial z}\right) = -\frac{\partial p}{\partial x} + \eta\left(\frac{\partial^2 u}{\partial x^2} + \frac{\partial^2 u}{\partial y^2} + \frac{\partial^2 u}{\partial z^2}\right)$$

$$\rho\left(u \frac{\partial v}{\partial x} + v \frac{\partial v}{\partial y} + w \frac{\partial v}{\partial z}\right) = -\frac{\partial p}{\partial y} + \eta\left(\frac{\partial^2 v}{\partial x^2} + \frac{\partial^2 v}{\partial y^2} + \frac{\partial^2 v}{\partial z^2}\right) - \rho g$$

$$\rho\left(u \frac{\partial w}{\partial x} + v \frac{\partial w}{\partial y} + w \frac{\partial w}{\partial z}\right) = -\frac{\partial p}{\partial z} + \eta\left(\frac{\partial^2 w}{\partial x^2} + \frac{\partial^2 w}{\partial y^2} + \frac{\partial^2 w}{\partial z^2}\right)$$

Because heat leaving right wall transfers to left wall:

$$\rho\left(u \frac{\partial T}{\partial x} + v \frac{\partial T}{\partial y} + w \frac{\partial T}{\partial z}\right) = \frac{\lambda}{c_p} \left(\frac{\partial^2 T}{\partial x^2} + \frac{\partial^2 T}{\partial y^2} + \frac{\partial^2 T}{\partial z^2}\right)$$

## Analysis for the computational domain:

This problem looks like Problem 3 where we take  $1/4$  of the cross section as the computational domain. Can we still take such practice for this case?

**No!** Because of the cross sectional natural convection the entire region must be taken as the computational domain.

### Boundary conditions:

At  $x=0$ ,  $T=T_c$ :  $x=L$ ,  $T=T_h$       At  $y=0$  and  $y=L$ : adiabatic

At four walls:  $u=v=w=0$ .

### Major features of the problem

(1) There are three velocity components:  $u$ ,  $v$ ,  $w$  ;

However  $u$ ,  $v$  are not coupled with  $w$  ;

(2) For the coordinate adopted, temperature is coupled only with  $v$ -component. (20191111) )

## 9-6-2 Numerical methods

(1) How to use 2-D code for solving three velocity components? **Using the partially coupled feature!**

$u, v, T$  are not coupled with  $w$ , while  $w$  is coupled with  $u$  and  $v$ ; Thus  $w$  can be regarded as a scalar variable:  $u, v, T$  are solved first, then  $w$  is solved;

(2) The problem studied can be resolved into two sub-problems:

(a) Natural convection in a 2-D square cavity:  $u, v, T$  are solved;

(b) Fully developed axial flow for solving  $w$ , with a prespecified source term of  $-dp/dz$ .

(3) Boussinesq assumption is adopted for  $v$ -equation:

Treatment of pressure gradient and gravitation term for  $v$ -equation

$$\begin{aligned}
 -\frac{\partial p}{\partial y} - \rho g &= -\frac{\partial p}{\partial y} - \rho_{ref} [1 - \beta(T - T_{ref})]g \\
 &= -\frac{\partial p}{\partial y} - \rho_{ref} (1 + \beta T_{ref})g + g \rho_{ref} \beta T \\
 &= -\frac{\partial}{\partial y} [\underbrace{p + \rho_{ref} (1 + \beta T_{ref})gy}_{\text{red underline}}] + g \rho_{ref} \beta T \\
 &= -\frac{\partial p_{eff}}{\partial y} + g \rho_{ref} \beta T
 \end{aligned}$$

Governing equations of the problem studied:

$$\rho \left( u \frac{\partial u}{\partial x} + v \frac{\partial u}{\partial y} \right) = - \frac{\partial p_{eff}}{\partial x} + \eta \left( \frac{\partial^2 u}{\partial x^2} + \frac{\partial^2 u}{\partial y^2} \right)$$

$$\rho \left( u \frac{\partial v}{\partial x} + v \frac{\partial v}{\partial y} \right) = - \frac{\partial p_{eff}}{\partial y} + \eta \left( \frac{\partial^2 v}{\partial x^2} + \frac{\partial^2 v}{\partial y^2} \right) + \rho g \beta T$$

$$\rho c_p \left( u \frac{\partial T}{\partial x} + v \frac{\partial T}{\partial y} \right) = \lambda \left( \frac{\partial^2 T}{\partial x^2} + \frac{\partial^2 T}{\partial y^2} \right)$$

$$\rho \left( u \frac{\partial w}{\partial x} + v \frac{\partial w}{\partial y} \right) = - \frac{dp}{dz} + \eta \left( \frac{\partial^2 w}{\partial x^2} + \frac{\partial^2 w}{\partial y^2} \right)$$

Solved first  
to get u, v  
and T

Solved 2<sup>nd</sup> with  
known u, v and  
specified pressure  
gradient!

$dp/dz$  ( $<0$ ) can be assumed and is specified as -3000.

## 9-6-3 Program reading

```
CCCCCCCCCCCCCCCCCCCCCCCCCCCCCCCCCCCCCCCCCCCCCCCCCCCCCCCC
  MODULE USER_L
C*****
  INTEGER*4 I,J
  REAL*8 GBR, DPDZ, PR, AMU, FRE, WBAR, TM
  END MODULE
CCCCCCCCCCCCCCCCCCCCCCCCCCCCCCCCCCCCCCCCCCCCCCCCCCCCCCCC
  SUBROUTINE USER
C*****
  USE START_L
  USE USER_L
  IMPLICIT NONE
C*****
C-----PROBLEM SEVEN-----
C      Complex fully developed laminar fluid flow and heat transfer in a
C      horizontal square duct
C*****
```

## ENTRY GRID

TITLE(1)=' .VEL U.'

TITLE(2)=' .VEL V.'

TITLE(3)=' .STR FN.'

TITLE(4)=' .TEMP.'

TITLE(5)=' .W/WBAR.'

! w is treated as fifth variable!

TITLE(11)='PRESSURE'

RELAX(1)=0.8

! Not for  $T, w$ ; With known  $u, v, T$  and  $w$  eqs are linear.

RELAX(2)=0.8

LSOLVE(1)=.TRUE.

LSOLVE(4)=.TRUE.

!  $u, v, p, T$  are solved first

LPRINT(1)=.TRUE.

LPRINT(2)=.TRUE.

LPRINT(3)=.TRUE.

LPRINT(4)=.TRUE.

LPRINT(5)=.TRUE.

LPRINT(11)=.TRUE.

! In SIMPLER code when the 1<sup>st</sup> variable is set to be solved, the 2<sup>nd</sup> and 3<sup>rd</sup> ones ( $v$  and  $p$ ) are automatically regarded as variables to be solved.

LAST=25

XL=1.

YL=1.

! Computation for the entire region

L1=7

M1=7

CALL UGRID

RETURN

## ENTRY START

GBR=1.E4 !  $\rho g \beta$

DPDZ=-3000.

DO 100 J=1,M1

DO 101 I=1,L1

U(I,J)=0.

V(I,J)=0.

T(I,J)=0.

T(L1,J)=1. !Initial temperature and right side boundary condition

F(I,J,5)=100. !Initial field for axial velocity

IF (I= =1.OR.I= =L1) F(I,J,5)=0. !Boundary cond. of w at four walls w=0

IF (J= =1.OR.J= =M1) F(I,J,5)=0.

101 ENDDO

100 ENDDO

!CPCON=1,default value

PR=0.7

!Pr =  $\mu c_p / \lambda$ ;  $\lambda = \mu c_p / Pr$

AMU=1.

!GAMA for temperature

AMUP=AMU\*CPCON/PR

RETURN

ENTRY DENSE

RETURN

With Bossinesq assumption,  
density is constant



## ENTRY BOUND

FRE=0.

IF(ITER<20) **RETURN** ! w is not solved when ITER<20

IF(.NOT.LSOLVE(5)) THEN

**LSOLVE(1)=.FALSE.**

**LSOLVE(5)=.TRUE.**

! Switch of the solved variables,  
only executed once

ENDIF

WBAR=0.

DO 302 J=2,M2

DO 303 I=2,L2

WBAR=WBAR+F(I,J,5)\*XCV(I)\*YCV(J) ! For computing av. velocity

303 ENDDO

302 ENDDO

! Computing (fRe) according to definition;  
Shown in the next page.

FRE=-DPDZ\*2.\*4.\*(XL\*YL)\*\*3/(XL+YL)\*\*2/(WBAR\*AMU)

**RETURN**

$$FRE = -DPDZ * 2. * 4. * (XL * YL) ** 3 / (XL + YL) ** 2 / (WBAR * AMU)$$

$$f Re = -[(dp / dz) D_h / \frac{1}{2} \rho w_m^2] \frac{\rho w_m D_h}{\mu}$$

$$f Re = -2[(dp / dz) D_h^2 / w_m \mu] = -\frac{2dp / dz}{\mu (\sum w_{i,j} \Delta A_{i,j} / A)} \cdot \left(\frac{4A}{P}\right)^2$$

$$= \frac{-2dp / dz}{\mu \sum w_{i,j} \Delta A_{i,j}} \cdot \left(\frac{4A}{P}\right)^2 A$$

$$= \frac{-2dp / dz}{\mu \sum w_{i,j} \Delta A_{i,j}} \cdot \left(\frac{4XL * YL}{2(XL + YL)}\right)^2 \cdot XL * YL$$

$$= \frac{-2dp / dz}{\mu \sum w_{i,j} \Delta A_{i,j}} \cdot \frac{4(XL * YL)^3}{(XL + YL)^2}$$

## ENTRY OUTPUT

```
IF(ITER= =0) THEN
  PRINT401
  WRITE(8,401)
401 FORMAT(1X,' ITER',6X,'SMAX',8X,'SSUM',7X,'V(6,4)',
  & 6X,'T(2,6)',6X,'F.RE')
  ELSE
    PRINT 403, ITER, SMAX, SSUM, V(6,4), T(2,6), FRE
    WRITE(8,403) ITER,SMAX,SSUM,V(6,4),T(2,6),FRE
403 FORMAT(1X,I6,1P5E12.3)
  ENDIF
  IF(ITER/=LAST) RETURN
  DO 410 J=1,M1
  DO 411 I=1,L1
  F(I,J,5)=F(I,J,5)/WBAR    !Dimensionless output for w
411 ENDDO
410 ENDDO
  CALL PRINT
  RETURN
```

### ENTRY GAMSOR

```
DO 500 J=1,M1
DO 501 I=1,L1
GAM(I,J)=AMU
IF(NF= = 4) THEN
GAM(I,J)=COND
GAM(I,1)=0.
GAM(I,M1)=0.
ENDIF
```

! GAMA for temp.

! Adiabatic for south and north boundaries

```
501ENDDO
500ENDDO
```

```
DO 510 J=2,M2
DO 511 I=2,L2
IF(NF= =2) THEN
IF(J/=2) THEN
TM=(T(I,J)+T(I,J-1))*0.5
CON(I,J)=TM*GBR
ENDIF
ENDIF
```

! Source term of V-eq.

$$GBR = g \rho_{ref} \beta T$$

```
IF(NF= =5) CON(I,J)=-DPDZ
```

511 ENDDO ! Source term of W-eq.

```
510 ENDDO
```

**RETURN**

END

TM

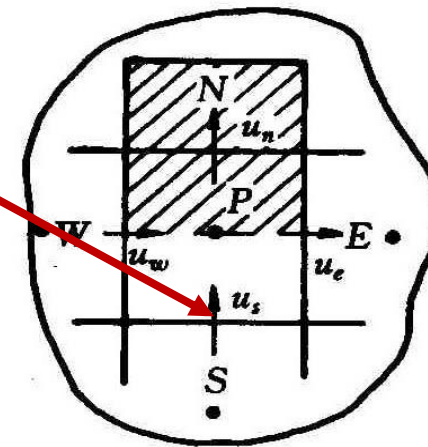

## 9-6-4 Results analysis

### COMPUTATION IN CARTESIAN COORDINATES

\*\*\*\*\*

ITER	SMAX	SSUM	V(6,4)	T(2,6)	F.RE
0	0.000E+00	0.000E+00	0.000E+00	0.000E+00	0.000E+00
1	0.000E+00	0.000E+00	0.000E+00	1.000E-01	0.000E+00
2	1.273E+01	-1.907E-06	1.016E+01	2.848E-01	0.000E+00
3	6.308E+00	1.073E-06	1.926E+01	3.445E-01	0.000E+00
4	2.978E+00	7.153E-07	2.076E+01	3.826E-01	0.000E+00
5	1.237E+00	-5.960E-07	2.284E+01	3.854E-01	0.000E+00
6	6.454E-01	-4.768E-07	2.304E+01	3.889E-01	0.000E+00
7	2.911E-01	7.153E-07	2.342E+01	3.894E-01	0.000E+00
8	1.338E-01	-3.278E-07	2.346E+01	3.900E-01	0.000E+00
9	6.046E-02	-5.364E-07	2.352E+01	3.900E-01	0.000E+00
10	2.868E-02	-5.364E-07	2.352E+01	3.900E-01	0.000E+00
11	1.286E-02	-4.321E-07	2.353E+01	3.900E-01	0.000E+00

**!F.RE**

12	6.224E-03	2.850E-07	2.353E+01	3.901E-01	0.000E+00
13	3.349E-03	-3.660E-07	2.353E+01	3.901E-01	0.000E+00
14	1.544E-03	1.974E-07	2.353E+01	3.901E-01	0.000E+00
15	8.407E-04	-2.626E-07	2.353E+01	3.901E-01	0.000E+00
16	3.686E-04	-1.118E-08	2.353E+01	3.901E-01	0.000E+00
17	1.961E-04	1.043E-07	2.353E+01	3.901E-01	0.000E+00
18	7.963E-05	2.775E-07	2.353E+01	3.901E-01	0.000E+00
19	4.327E-05	3.166E-08	2.353E+01	3.901E-01	0.000E+00
20	2.098E-05	-1.825E-07	2.353E+01	3.901E-01	6.000E+01
21	2.098E-05	-1.825E-07	2.353E+01	3.901E-01	5.323E+01
22	2.098E-05	-1.825E-07	2.353E+01	3.901E-01	5.238E+01
23	2.098E-05	-1.825E-07	2.353E+01	3.901E-01	5.236E+01
24	2.098E-05	-1.825E-07	2.353E+01	3.901E-01	5.236E+01
25	2.098E-05	-1.825E-07	2.353E+01	3.901E-01	5.236E+01

**!Solving w-eq.**

\*\*\*\*\* .VEL U. \*\*\*\*\*

I =	2	3	4	5	6	7
J						
7	0.00E+00	0.00E+00	0.00E+00	0.00E+00	0.00E+00	0.00E+00
6	0.00E+00	-1.52E+01	-1.78E+01	-1.77E+01	-1.31E+01	0.00E+00
5	0.00E+00	-8.36E+00	-1.40E+01	-1.40E+01	-9.70E+00	0.00E+00
4	0.00E+00	7.76E-01	8.31E-02	-8.31E-02	-7.76E-01	0.00E+00
3	0.00E+00	9.70E+00	1.40E+01	1.40E+01	8.36E+00	0.00E+00
2	0.00E+00	1.31E+01	1.77E+01	1.78E+01	1.52E+01	0.00E+00
1	0.00E+00	0.00E+00	0.00E+00	0.00E+00	0.00E+00	0.00E+00

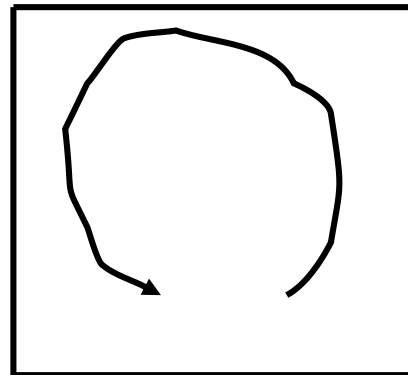

Natural convection  
in cross section

\*\*\*\*\* .VEL V. \*\*\*\*\*

I =	1	2	3	4	5	6	7
J							
7	0.00E+00	0.00E+00	0.00E+00	0.00E+00	0.00E+00	0.00E+00	0.00E+00
6	0.00E+00	-1.52E+01	-2.64E+00	1.01E-01	4.66E+00	1.31E+01	0.00E+00
5	0.00E+00	-2.35E+01	-8.26E+00	8.31E-02	8.96E+00	2.28E+01	0.00E+00
4	0.00E+00	-2.28E+01	-8.96E+00	-8.31E-02	8.26E+00	2.35E+01	0.00E+00
3	0.00E+00	-1.31E+01	-4.66E+00	-1.01E-01	2.64E+00	1.52E+01	0.00E+00
2	0.00E+00	0.00E+00	0.00E+00	0.00E+00	0.00E+00	0.00E+00	0.00E+00

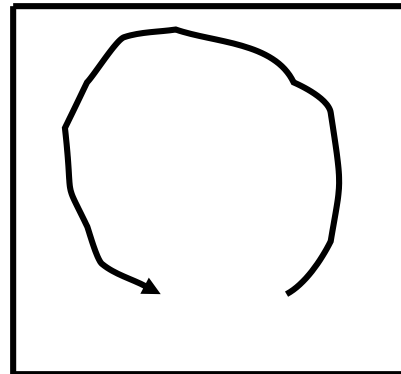



\*\*\*\*\*.STR FN.\*\*\*\*\*

I =	2	3	4	5	6	7
J						
7	0.00E+00	-3.91E-07	2.60E-07	1.16E-07	1.26E-08	0.00E+00
6	0.00E+00	3.03E+00	3.56E+00	3.54E+00	2.61E+00	0.00E+00
5	0.00E+00	4.71E+00	6.36E+00	6.34E+00	4.55E+00	0.00E+00
4	0.00E+00	4.55E+00	6.34E+00	6.36E+00	4.71E+00	0.00E+00
3	0.00E+00	2.61E+00	3.54E+00	3.56E+00	3.03E+00	0.00E+00
2	0.00E+00	0.00E+00	0.00E+00	0.00E+00	0.00E+00	0.00E+00

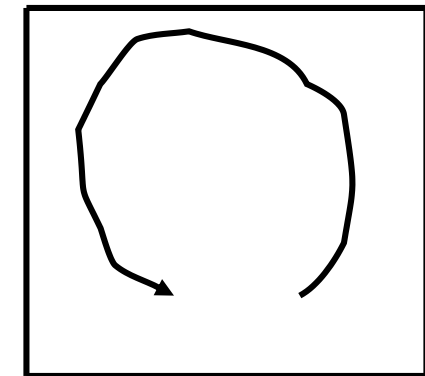

Stream functions of the four walls are zero

\*\*\*\*\* . TEMP . \*\*\*\*\*

I =	1	2	3	4	5	6	7
J							
7	0.00E+00	0.00E+00	0.00E+00	0.00E+00	0.00E+00	0.00E+00	1.00E+00
6	0.00E+00	3.90E-01	7.20E-01	7.86E-01	8.33E-01	9.11E-01	1.00E+00
5	0.00E+00	3.25E-01	6.21E-01	6.77E-01	7.15E-01	8.43E-01	1.00E+00
4	0.00E+00	2.41E-01	4.58E-01	5.00E-01	5.42E-01	7.59E-01	1.00E+00
3	0.00E+00	1.57E-01	2.85E-01	3.23E-01	3.79E-01	6.75E-01	1.00E+00
2	0.00E+00	8.92E-02	1.67E-01	2.14E-01	2.80E-01	6.10E-01	1.00E+00
1	0.00E+00	0.00E+00	0.00E+00	0.00E+00	0.00E+00	0.00E+00	1.00E+00

No decoration

No decoration

\*\*\*\*\* .W/WBAR. \*\*\*\*\*

I =	1	2	3	4	5	6	7
J							
7	0.00E+00	0.00E+00	0.00E+00	0.00E+00	0.00E+00	0.00E+00	0.00E+00
6	0.00E+00	4.96E-01	7.74E-01	7.73E-01	6.99E-01	4.72E-01	0.00E+00
5	0.00E+00	7.89E-01	1.50E+00	1.54E+00	1.34E+00	7.52E-01	0.00E+00
4	0.00E+00	8.21E-01	1.63E+00	<b>1.85E+00</b>	1.63E+00	8.21E-01	0.00E+00
3	0.00E+00	7.52E-01	1.34E+00	1.54E+00	1.50E+00	7.89E-01	0.00E+00
2	0.00E+00	4.72E-01	6.99E-01	7.73E-01	7.74E-01	4.96E-01	0.00E+00
1	0.00E+00	0.00E+00	0.00E+00	0.00E+00	0.00E+00	0.00E+00	0.00E+00

W velocity of the four walls are zero

\*\*\*\*\* PRESSURE \*\*\*\*\*

I =	1	2	3	4	5	6	7
J							
7	3.64E+03	3.73E+03	4.05E+03	4.33E+03	4.67E+03	4.89E+03	5.00E+03
6	3.09E+03	3.18E+03	3.36E+03	3.56E+03	3.84E+03	4.05E+03	4.16E+03
5	2.14E+03	2.09E+03	1.99E+03	2.02E+03	2.17E+03	2.36E+03	2.46E+03
4	1.10E+03	1.02E+03	8.42E+02	7.85E+02	8.42E+02	1.02E+03	1.10E+03
3	4.58E+02	3.63E+02	1.73E+02	2.45E+01	-7.31E+00	9.20E+01	1.42E+02
2	1.56E+02	5.04E+01	-1.61E+02	-4.37E+02	-6.35E+02	-8.17E+02	-9.08E+02
1	0.00E+00	-1.06E+02	-3.28E+02	-6.67E+02	-9.49E+02	-1.27E+03	-1.36E+03

Pmax



Pressure reference point



Pmin



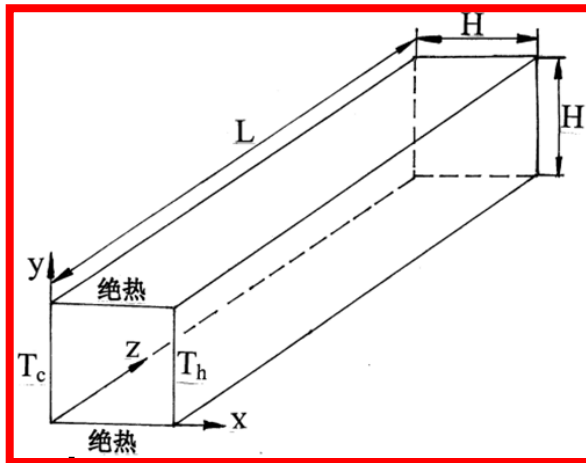
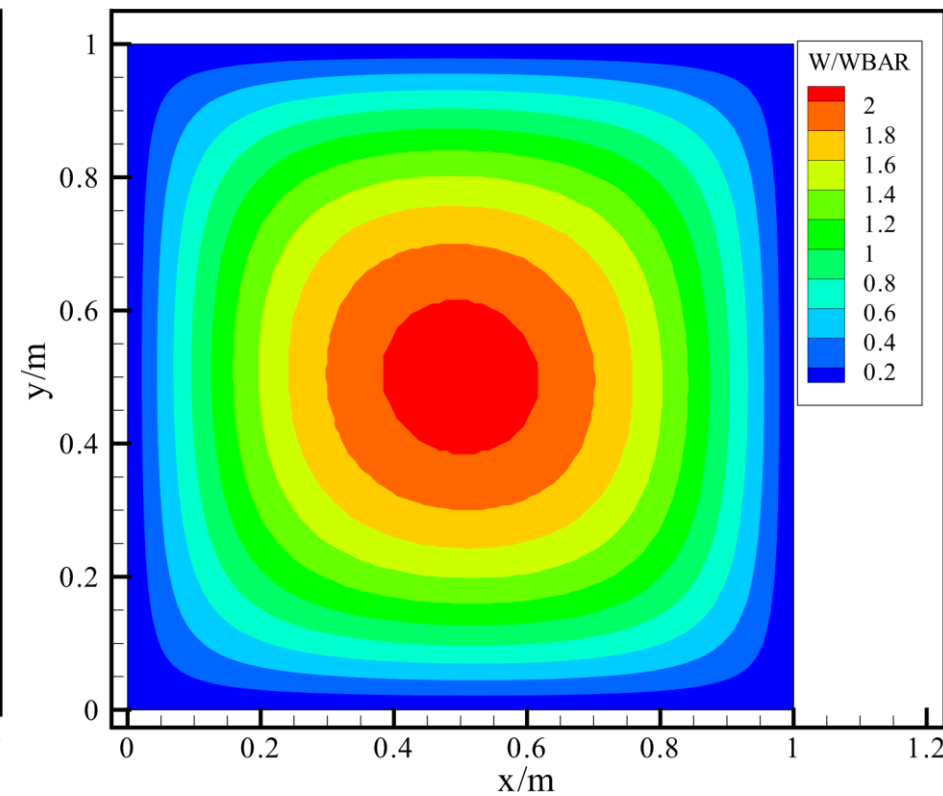
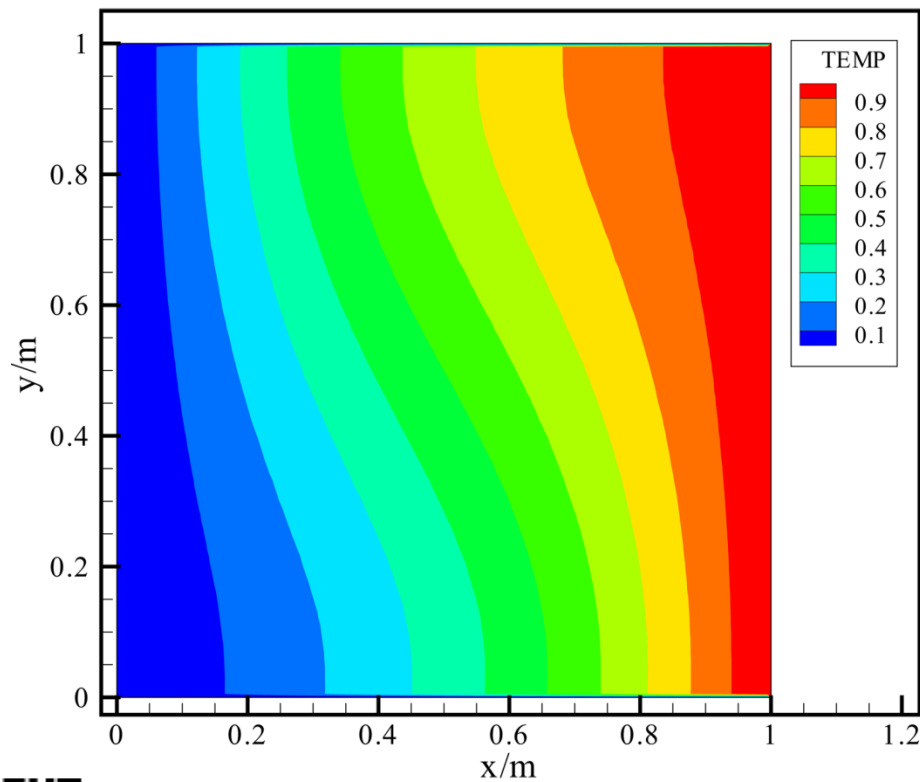

Fig. 2 Results of Problem 6



## 9-7 Impinging flow on a rotating disc

### ---Discretization of source term of momentum equation in cylindrical coordinate

#### 9-7-1 Physical problem and its math formulation

**Known:** A rotating disc with  $\omega=100$  is partially covered by a shell (壳体). Fluid flows into the shell through the central inlet of the shell with inlet velocity  $U_{in}=100$ , impinges onto the disc and then leaves the disc (盘) through the gap between the shell and the disc. Fluid viscosity  $\mu=1$ .

Fig.1 Schematic diagram of problem 7

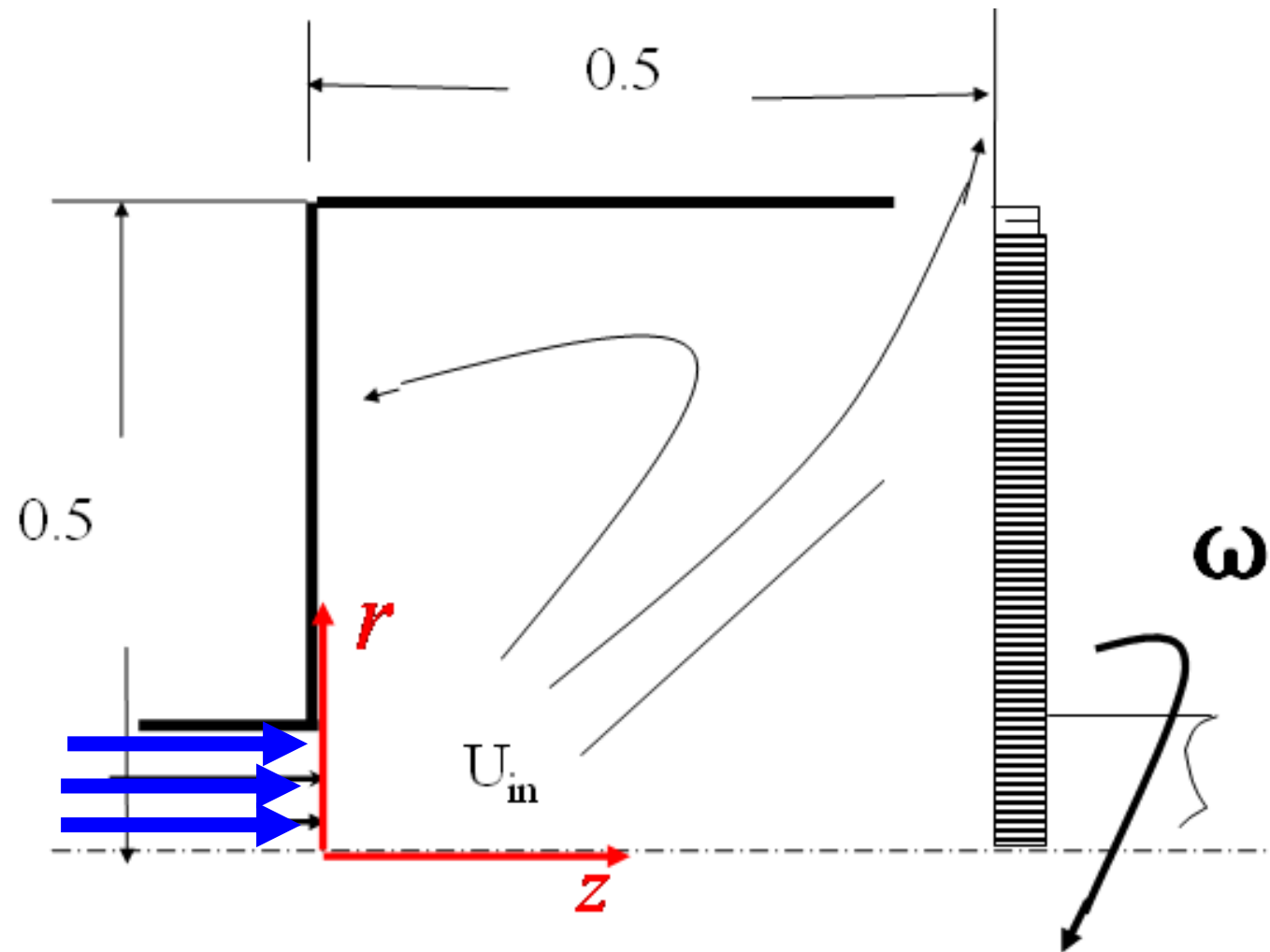

No change along the peripheral direction(圆周方向)

**Find:** Velocity and pressure distribution in the cavity.

**Solution:** This is a fluid flow problem in three dimensional cylindrical coordinate. The rotating disc and the shell form a cavity. The fluid flow within the cavity is caused by the impingement of the inlet flow and the rotating effect of the disc. The circumferential velocity component is purely caused by the rotating disc. Thus there exists circumferential velocity component, but no circumferential pressure drop .



Governing equations of the three velocities are:

$$z \text{ direction : } \rho \left( v_r \frac{\partial v_z}{\partial r} + v_z \frac{\partial v_z}{\partial z} \right) = -\frac{\partial p}{\partial z} + \eta \left( \frac{\partial^2 v_z}{\partial z^2} + \frac{1}{r} \frac{\partial}{\partial r} \left( r \frac{\partial v_z}{\partial r} \right) \right)$$

$$r \text{ direction : } \rho \left( v_r \frac{\partial v_r}{\partial r} + v_z \frac{\partial v_r}{\partial z} \right) = -\frac{\partial p}{\partial r} + \eta \left( \frac{\partial^2 v_r}{\partial z^2} + \frac{1}{r} \frac{\partial}{\partial r} \left( r \frac{\partial v_r}{\partial r} \right) \right)$$

$$+ \rho \frac{v_\theta^2}{r} - \eta \frac{v_r}{r^2} \quad \leftarrow \text{Source term}$$

$$\theta \text{ direction : } \rho \left( v_r \frac{\partial v_\theta}{\partial r} + v_z \frac{\partial v_\theta}{\partial z} \right) = 0 + \eta \left( \frac{\partial^2 v_\theta}{\partial z^2} + \frac{1}{r} \frac{\partial}{\partial r} \left( r \frac{\partial v_\theta}{\partial r} \right) \right)$$

$$- \rho \frac{v_r v_\theta}{r} - \eta \frac{v_\theta}{r^2} \quad \leftarrow \text{Source term}$$

**Zero pressure gradient!**

**There exists  $v_\theta$  but no term with  $\frac{\partial}{\partial \theta}$ .**

Since the circumferential flow is caused by shear stress, there is no pressure gradient in  $\theta$  direction.

## 9-7-2 Numerical method

(1) There are three velocity components, but no terms contain  $\partial/\partial\theta$ , such as no terms with  $\partial/\partial z$  in Example 6.

(2)  $v_\theta$  is not in the convection terms of  $v_z, v_r$ , but it is included in the source term of  $v_r$ .  $v_\theta$  can be viewed as a scalar variable (such as temperature) coupled with  $v_r, v_z$ ; Thus it is 2-D cylindrical case with  $\text{MODE}=2$ .

(3)  $rv_\theta$  will be taken as variable to be solved to

enhance solution stability .

**The original momentum eq. of  $\theta$  direction :**

$$\rho(v_r \frac{\partial v_\theta}{\partial r} + v_z \frac{\partial v_\theta}{\partial z}) = \eta(\frac{\partial^2 v_\theta}{\partial z^2} + \frac{1}{r} \frac{\partial}{\partial r} (r \frac{\partial v_\theta}{\partial r}))$$

**It is transformed to:**  $\rho(v_r \frac{\partial(rv_\theta)}{\partial r} + v_z \frac{\partial(rv_\theta)}{\partial z}) =$

$$\eta(\frac{\partial^2(rv_\theta)}{\partial z^2} + \frac{1}{r} \frac{\partial}{\partial r} (r \frac{\partial(rv_\theta)}{\partial r})) - \frac{2\eta}{r} \frac{\partial(rv_\theta)}{\partial r}$$

**(4) The source term of  $v_r$  is transformed as follows:**

$$S_{v_r} = \rho \frac{v_\theta^2}{r} - \eta \frac{v_r}{r^2} = \rho \frac{(rv_\theta)^2}{r^3} - \underbrace{\eta \frac{1}{r^2}}_{S_p} v_r$$



Fig.1 Schematic diagram of Example 7

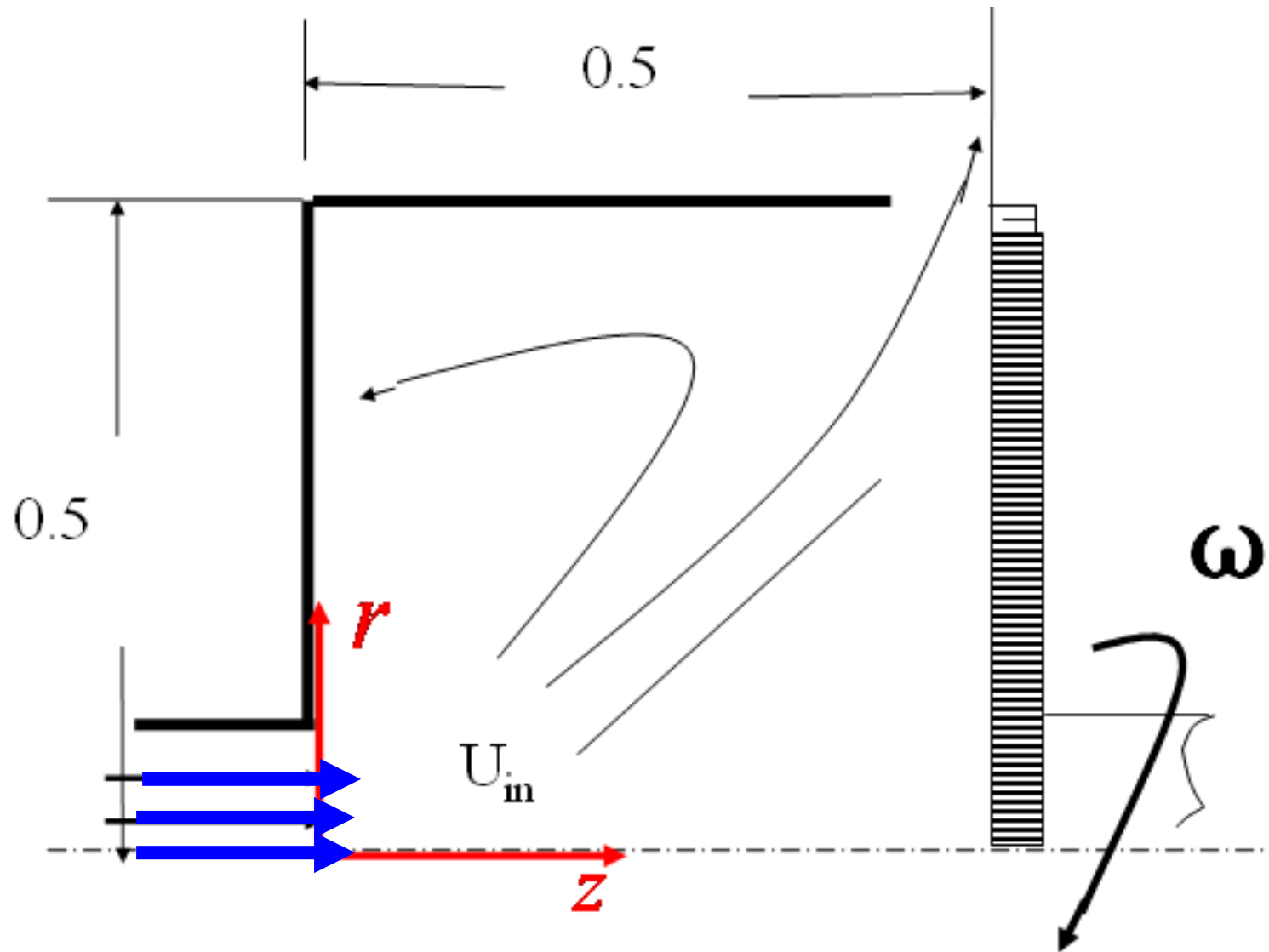

## 9-7-3 Program reading

```
CCCCCCCCCCCCCCCCCCCCCCCCCCCCCCCCCCCCCCCCCCCCCCCCCCCCCCCCCCCC
MODULE USER_L
C*****
INTEGER*4 I,J
REAL*8 OMEGA, UIN, AMU, FLOWIN, AR, ADD, FL,
1 RSWM, RHOM, FLT
END MODULE
CCCCCCCCCCCCCCCCCCCCCCCCCCCCCCCCCCCCCCCCCCCCCCCCCCCCCCCCCCCC
SUBROUTINE USER
C*****
USE START_L
USE USER_L
IMPLICIT NONE
C*****
C-----PROBLEM EIGHT-----
C
C          Laminar impinging flow over a rotating disk
C*****
```

## ENTRY GRID

TITLE(1)=' .VEL U.'

TITLE(2)=' .VEL V.'

TITLE(3)=' .STR FN.'

TITLE(5)=' .R.VTH.'

TITLE(11)='PRESSURE'

RELAX(1)=0.8

RELAX(2)=0.8

LSOLVE(1)=.TRUE.

LSOLVE(5)=.TRUE.

LPRINT(1)=.TRUE.

LPRINT(2)=.TRUE.

LPRINT(3)=.TRUE.

LPRINT(5)=.TRUE.

LPRINT(11)=.TRUE.

LAST=25

MODE=2

XL=0.5

YL=0.5

L1=7

M1=7

R(1)=0.

CALL UGRID

**RETURN**

———— Regarding (R.VTheta) as 5<sup>th</sup> variable

In SIMPLER code when the 1<sup>st</sup> variable is set to be solved, the 2<sup>nd</sup> and 3<sup>rd</sup> ones are automatically regarded as variables to be solved.

**ENTRY START**

**OMEGA=100.**

**UIN=100.**

**DO 100 J=1,M1**

**DO 101 I=1,L1**

**U(I,J)=0.**

**V(I,J)=0.**

**F(I,J,5)=0.**

**F(L1,J,5)=R(J)\*\*2\*OMEGA** 5<sup>th</sup> variable is R.VTheta

**101 ENDDO**

**! Velocity on disc, causing circumferential movement**

**100 ENDDO**

**U(2,2)=UIN**

**AMU=1.**

**RETURN**

\*

**ENTRY DENSE**

**RETURN**

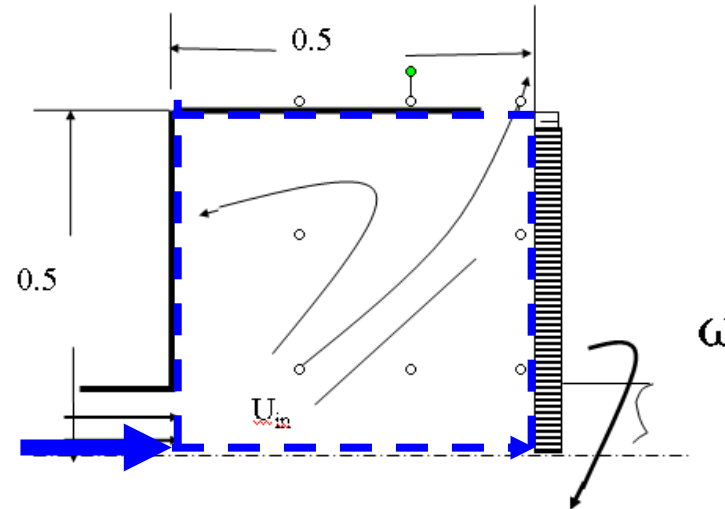

$$r \bullet v_{\theta} = r \cdot \omega r = \omega r^2$$

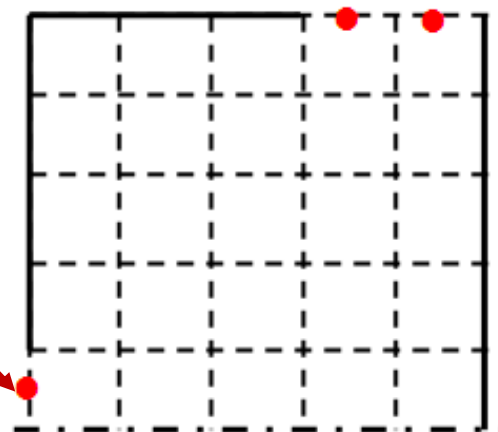



One way for obtaining outlet velocity of open system:

Assuming that the 1<sup>st</sup> derivatives at outlet = constant

$$\frac{v_{i,M1} - v_{i,M2}}{\Delta y} = k = \text{const} \quad \longrightarrow \quad v_{i,M1} = v_{i,M2} + k\Delta y = v_{i,M2} + C$$

**C is determined according to total mass conservation**

$$\sum_{i=2}^{L2} \rho_{i,M1} (v_{i,M2} + C) \Delta x_i = \text{FLOWIN} \quad \longrightarrow$$

$$C = \frac{\text{FLOWIN} - \sum \rho_{i,M1} v_{i,M2} \Delta x_i}{\sum \rho_{i,M1} \Delta x_i}$$

$v_{i,M1} = v_{i,M2}^* + C$  is taking as boundary condition for next iteration.

**In this example this method is used**

## ENTRY BOUND

```

IF(ITER.NE.0) FLOWIN=RHO(1,2)*U(2,2)*YCVR(2)

FL=0.
AR=0.
DO 301 I=L3,L2
    FLT=R(M1)*XCV(I)*RHO(I,M1)
    AR=AR+FLT ! Denominator
    FL=FL+FLT*V(I,M2)
    ! 2nd part of the Numerator
301 ENDDO
ADD=(FLOWIN-FL)/AR
DO 302 I=L3,L2 ! C---ADD
    V(I,M1)=V(I,M2)+ADD
302 ENDDO
    
```

! FLOWIN =

$$\sum \rho(I,M1) \cdot XCV(I,M1) \cdot R(I,M1) \cdot (V(I,M2)+C)$$

$$! C = \frac{\text{FLOWIN} - \sum \rho(i,M1) \cdot XCV(i) \cdot R(M1) \cdot V(i,M2)}{\sum \rho(i,M1) \cdot XCV(i) \cdot R(M1)}$$

!C-method is adopted to  
 guarantee the total mass  
 conservation condition

RETURN

## ENTRY OUTPUT

```
IF(ITER= =0) THEN
PRINT 401
WRITE(8,401)
401 FORMAT(1X,' ITER',7X,'SMAX',11X,'SSUM',10X,'U(4,4)',
& 9X,'V(4,4)')
ELSE
PRINT 403
WRITE(8,403) ITER,SMAX,SSUM,U(4,4),V(4,4)
403 FORMAT(1X,I6,1P5E15.4)
ENDIF
IF(ITER= =LAST) CALL PRINT
RETURN
```

### ENTRY GAMSOR

```
IF(ITER= = 0) THEN
```

```
DO 500 J=1,M1
```

```
DO 501 I=1,L1
```

```
GAM(I,J)=AMU
```

```
501 ENDDO
```

```
502 ENDDO
```

```
GAM(L3,M1)=0.
```

```
GAM(L2,M1)=0.
```

```
ENDIF
```

! Constant viscosity, calculation once is enough

! Local one-way for outlet

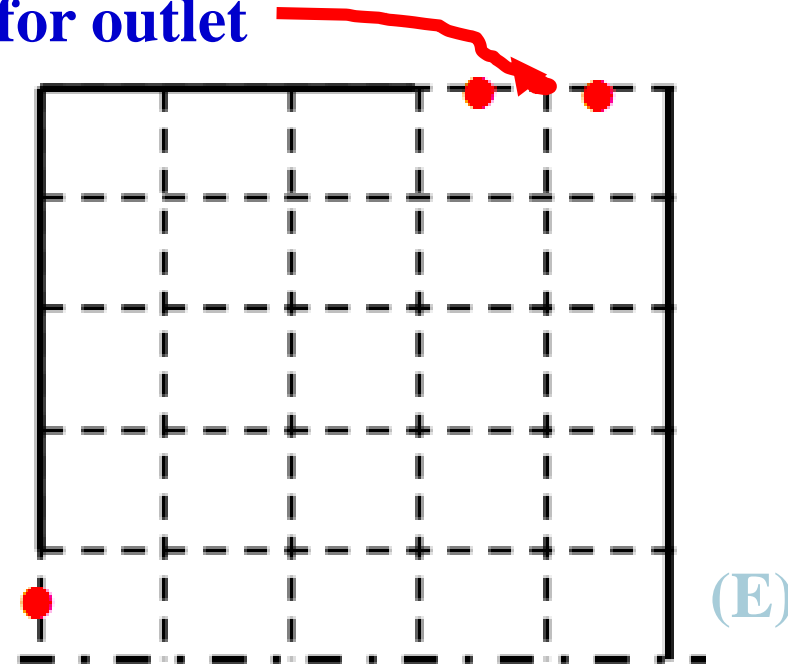

```

IF(NF== 2) THEN
DO 502 J=3,M2
DO 503 I=2,L2
RSWM=FY(J)*F(I,J,4)+FYM(J)*F(I,J-1,4)
RHOM=FY(J)*RHO(I,J)+FYM(J)*RHO(I,J-1)
CON(I,J)=RHOM*RSWM**2/RMN(J)**3
AP(I,J)=-AMU/RMN(J)**2
503 ENDDO
502 ENDDO
ENDIF

```

**! Source term of v –eq.**  
**!  $rv_\theta$  Is interpolated from main nodes**  
**! Interface density is interpolated from node density for the source term of Vr**

$$S_{v_r} = \rho \frac{v_\theta^2}{r} - \eta \frac{v_r}{r^2} = \rho \frac{(rv_\theta)^2}{r^3} - \eta \frac{1}{r^2} v_r$$

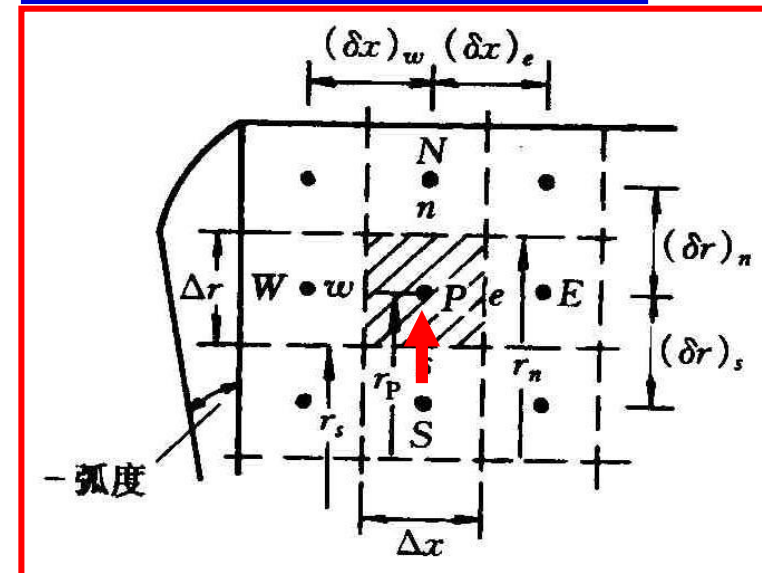

510 IF(NF/=5) RETURN

DO 512 J=2,M2 ! Source term of  $rv_\theta$  is calculated at main node

DO 513 I=2,L2

AR=2.\*AMU/YCVR(J)

CON(I,J)=AR\*F(I,J-1,5)

AP(I,J)=-AR

512 ENDDO

513 ENDDO

RETURN

END

$$S_{(rv_\theta)} = \frac{2}{r_P} \frac{\eta (rv_\theta)_S}{YCV(j)} - \frac{2}{r_P} \frac{\eta}{YCV(j)} (rv_\theta)_P$$

$$= \frac{2\eta}{YCVR(j)} (rv_\theta)_S - \frac{2\eta}{YCVR(j)} (rv_\theta)_P$$

## 9-7-4 Results analysis

### COMPUTATION FOR AXISYMMETRICAL SITUATION

\*\*\*\*\*

ITER	SMAX	SSUM	U(4,4)	V(4,4)
0	0.0000E+00	0.0000E+00	0.0000E+00	0.0000E+00
1	3.1852E-01	0.0000E+00	3.3742E+00	4.8158E+00
2	3.6224E-01	1.1921E-07	2.9314E+00	7.6065E+00
3	1.1265E-01	7.4506E-09	1.8755E+00	8.5863E+00
4	6.1974E-02	-3.7253E-08	1.5199E+00	8.8029E+00
5	3.2279E-02	-3.1665E-08	1.2971E+00	8.4019E+00
6	1.7869E-02	-4.0280E-08	1.2738E+00	7.6836E+00
7	1.2370E-02	5.1223E-09	1.3363E+00	6.8852E+00
8	1.0312E-02	-1.1176E-08	1.4400E+00	6.1421E+00
9	7.9294E-03	-2.9569E-08	1.5480E+00	5.5244E+00
10	5.9429E-03	4.8894E-08	1.6437E+00	5.0452E+00
11	4.6140E-03	-1.6531E-08	1.7207E+00	4.6926E+00
12	3.3741E-03	3.1199E-08	1.7787E+00	4.4432E+00
13	2.6291E-03	-5.1106E-08	1.8202E+00	4.2728E+00

			<b>!U(4,4)</b>	<b>!V(4,4)</b>
14	1.9695E-03	-2.6543E-08	1.8486E+00	4.1597E+00
15	1.4364E-03	6.2981E-08	1.8674E+00	4.0867E+00
16	1.0142E-03	-4.5111E-08	1.8792E+00	4.0409E+00
17	6.9815E-04	8.9640E-09	1.8864E+00	4.0129E+00
18	4.6667E-04	3.8388E-08	1.8906E+00	3.9963E+00
19	3.0389E-04	3.3469E-09	1.8929E+00	3.9868E+00
20	1.9290E-04	-1.1176E-08	1.8941E+00	3.9816E+00
21	1.1830E-04	5.2169E-09	1.8946E+00	3.9790E+00
22	7.0846E-05	4.6941E-08	1.8947E+00	3.9778E+00
23	4.0823E-05	5.4388E-08	1.8947E+00	3.9773E+00
24	2.2590E-05	-8.0094E-08	1.8945E+00	3.9772E+00
25	1.1003E-05	-3.8743E-08	1.8944E+00	3.9773E+00



\*\*\*\*\*.VEL U.\*\*\*\*\*

I =	2	3	4	5	6	7
J						
7	0.00E+00	0.00E+00	0.00E+00	0.00E+00	0.00E+00	0.00E+00
6	0.00E+00	-1.33E+00	-2.67E+00	-2.12E+00	-8.37E-01	0.00E+00
5	0.00E+00	-1.86E+00	-2.70E+00	-1.86E+00	-6.39E-01	0.00E+00
4	0.00E+00	-2.17E-01	1.89E+00	2.90E+00	1.65E+00	0.00E+00
3	0.00E+00	1.33E+01	1.97E+01	1.92E+01	1.04E+01	0.00E+00
2	1.00E+02	8.63E+01	7.43E+01	5.99E+01	3.27E+01	0.00E+00
1	0.00E+00	0.00E+00	0.00E+00	0.00E+00	0.00E+00	0.00E+00



\*\*\*\*\* .VEL V. \*\*\*\*\*

I =	1	2	3	4	5	6	7
J							
7	0.00E+00	0.00E+00	0.00E+00	0.00E+00	3.99E+00	6.01E+00	0.00E+00
6	0.00E+00	-1.50E+00	-1.50E+00	6.18E-01	6.44E+00	8.45E+00	0.00E+00
5	0.00E+00	-4.17E+00	-2.98E+00	1.81E+00	1.00E+01	1.20E+01	0.00E+00
4	0.00E+00	-6.53E+00	-1.84E+00	3.98E+00	1.34E+01	1.60E+01	0.00E+00
3	0.00E+00	6.87E+00	5.96E+00	7.21E+00	1.36E+01	1.63E+01	0.00E+00
2	0.00E+00	0.00E+00	0.00E+00	0.00E+00	0.00E+00	0.00E+00	0.00E+00



\*\*\*\*\* .STR FN. \*\*\*\*\*

I =	2	3	4	5	6	7
J						
7	5.00E-01	5.00E-01	5.00E-01	5.00E-01	3.00E-01	0.00E+00
6	5.00E-01	5.60E-01	6.20E-01	5.95E-01	3.38E-01	0.00E+00
5	5.00E-01	6.25E-01	7.15E-01	6.60E-01	3.60E-01	0.00E+00
4	5.00E-01	6.31E-01	6.67E-01	5.88E-01	3.19E-01	0.00E+00
3	5.00E-01	4.31E-01	3.72E-01	3.00E-01	1.63E-01	0.00E+00
2	0.00E+00	0.00E+00	0.00E+00	0.00E+00	0.00E+00	0.00E+00

At the shell flow rate is constant

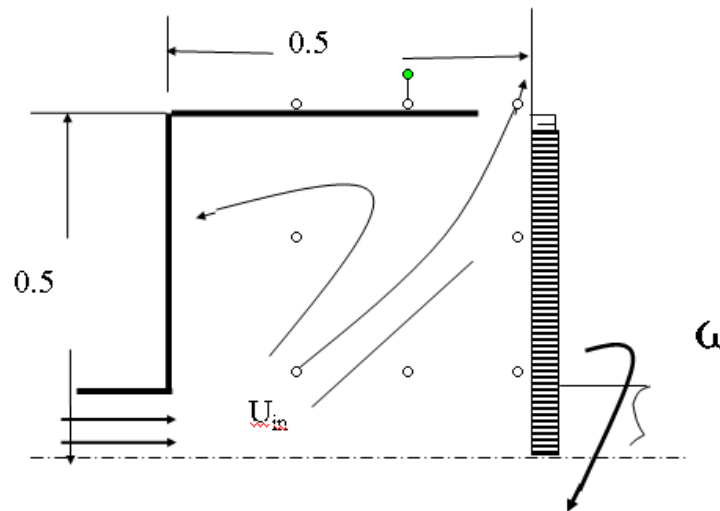

Zero flow rate on disc

\*\*\*\*\* R. VTH \*\*\*\*\*

I =	1	2	3	4	5	6	7
J							
7	0.00E+00	0.00E+00	0.00E+00	0.00E+00	0.00E+00	0.00E+00	2.50E+01
6	0.00E+00	1.24E-01	5.24E-01	1.64E+00	5.76E+00	1.26E+01	2.02E+01
5	0.00E+00	2.02E-01	7.28E-01	1.69E+00	3.66E+00	7.75E+00	1.23E+01
4	0.00E+00	1.40E-01	4.46E-01	8.49E-01	1.53E+00	3.54E+00	6.25E+00
3	0.00E+00	5.15E-02	1.49E-01	2.47E-01	3.84E-01	1.09E+00	2.25E+00
2	0.00E+00	4.66E-03	1.84E-02	3.72E-02	5.53E-02	1.55E-01	2.50E-01
1	0.00E+00	0.00E+00	0.00E+00	0.00E+00	0.00E+00	0.00E+00	0.00E+00

$\omega * r^2$

\*\*\*\*\* PRESSURE \*\*\*\*\*

I =	1	2	3	4	5	6	7
J							
7	-4.93E+02	-4.81E+02	-4.57E+02	-3.68E+02	-3.47E+02	-3.61E+02	-3.61E+02
6	-5.08E+02	-4.96E+02	-4.72E+02	-3.94E+02	-3.61E+02	-3.61E+02	-3.61E+02
5	-5.38E+02	-5.26E+02	-5.02E+02	-4.46E+02	-3.89E+02	-3.61E+02	-3.47E+02
4	-6.85E+02	-6.47E+02	-5.72E+02	-4.92E+02	-3.60E+02	-2.41E+02	-1.81E+02
3	-1.15E+03	-9.63E+02	-5.97E+02	-4.57E+02	-1.85E+02	1.02E+02	2.46E+02
2	-3.01E+02	-3.62E+02	-4.84E+02	-3.04E+02	1.83E+02	6.20E+02	8.39E+02
1	0.00E+00	-6.11E+01	-4.27E+02	-2.28E+02	3.67E+02	8.79E+02	<b>1.10E+03</b>

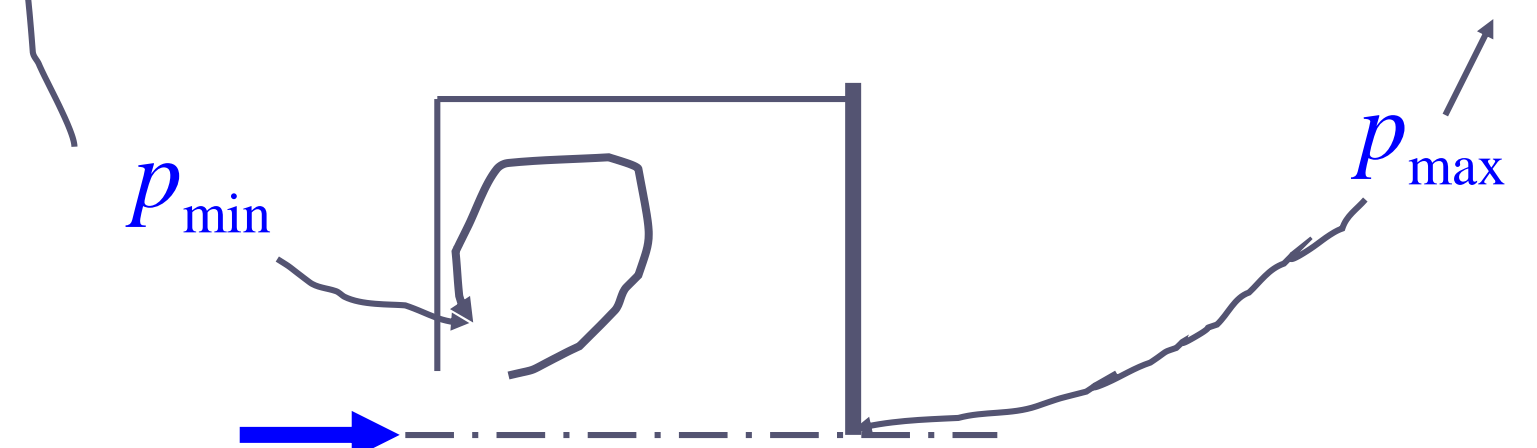

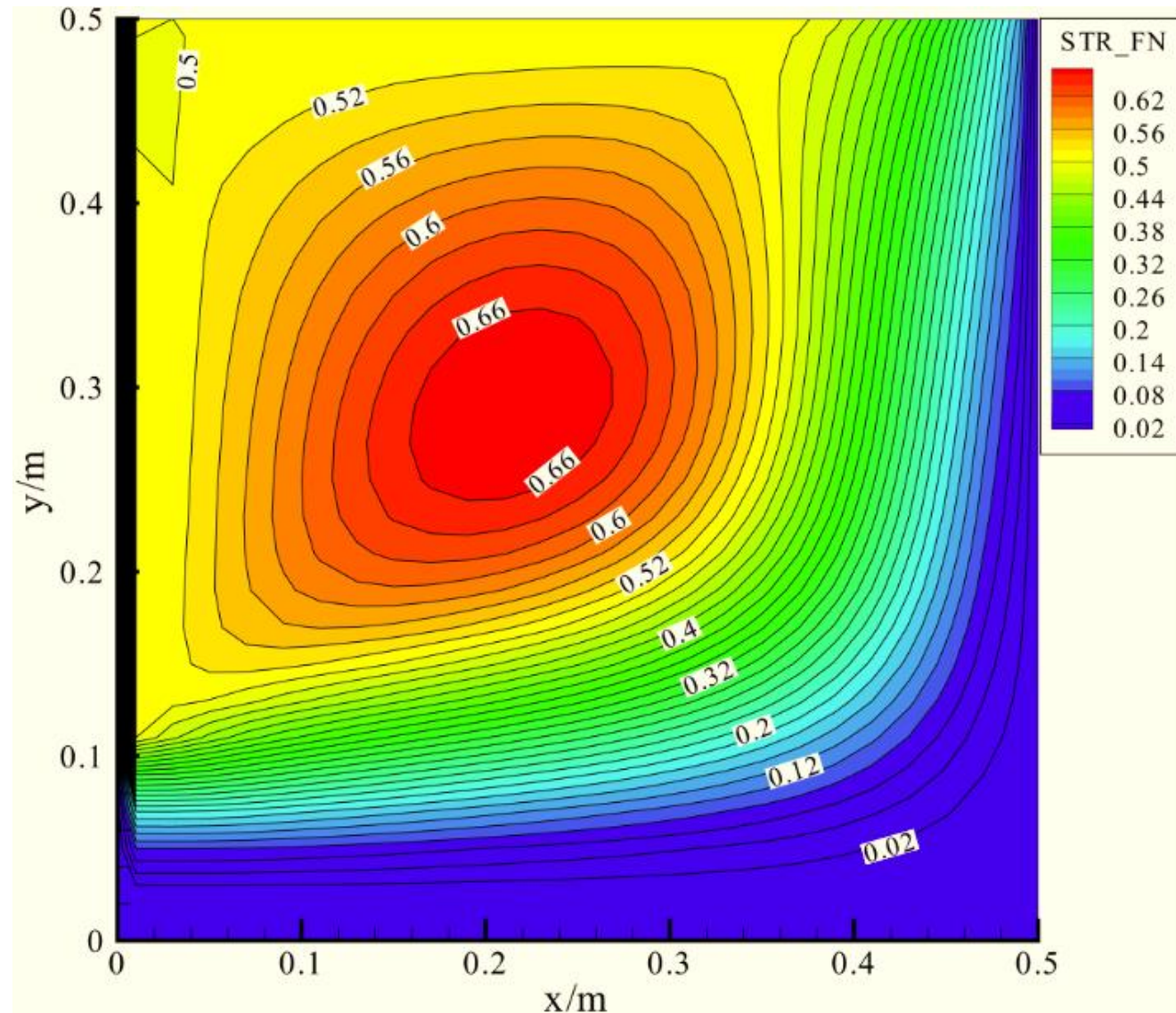

Fig.2 Schematic diagram of Section 7

本组网页地址: <http://nht.xjtu.edu.cn> 欢迎访问!  
*Teaching PPT will be loaded on ou website*



同舟共济  
渡彼岸!

People in the  
same boat help  
each other to  
cross to the other  
bank, where....